

Plunger Pumps

Please read and save these instructions. Read carefully before attempting to assemble, install, operate or maintain the product described. Protect yourself and others by observing all safety information. Failure to comply with instructions could result in personal injury and/or property damage! Retain instructions for future reference.

Description

Plunger Pumps are designed for high-pressure industrial washing applications. They are constructed of die-cast bodies and feature a forged brass heads with a bayonet style sight glass in the rear and side covers. Internal components include special thick solid ceramic plungers for long life and durability. Precision cast cooling fins are anodized for maximum heat dissipation. Oversized premium SKF tapered roller bearings and the precision die-cast supports assure proper shaft alignment and maximum life. Valve cages of Ultra-Form provide positive seating and extended life, especially designed for high pressure applications. Two-piece connecting rods are a special alloy aluminum-based material oversized for maximum strength and load disbursement. These pumps are designed for gearbox flex coupled or belt drive systems with a 24mm solid crankshaft. Spinning at 1450 RPM, this pump was designed to deliver 5.55 GPM at 5000 PSI.



Figure 1

SXMA 1750 rpm E Version - 1-18"

Model	Max GPM	Max PSI
SXMA3G30E-F17	3.0	3000
SXMA3.5G30E-F17	3.5	3000
SXMA4G30E-F17	4.0	3000

SXMV 3400 rpm D Version - 1"

Model	Max GPM	Max PSI
SXMV3G40D-F24	3.0	4000
SXMV3.5G40D-F24	3.5	4000
SXMV4G35D-F24	4.0	3500

SXW 1450 rpm N Version

Model	Max GPM	Max PSI
SXW15.35	3.96	5100
SXW21.35	3.55	5100

SXWA 1750 rpm N Version

Model	Max GPM	Max PSI
SXWA4G50	4.0	5000
SXWA5.5G50	5.5	5000
SXWA7G50	7.0	5000

Available from Allparts Equipment and Accessories - 1-877-475-5660 - www.allpartsinc.com

Plunger Pumps

SXMA

E version 1" 1/8 + F17
Hollow shaft pump \varnothing 1" 1/8

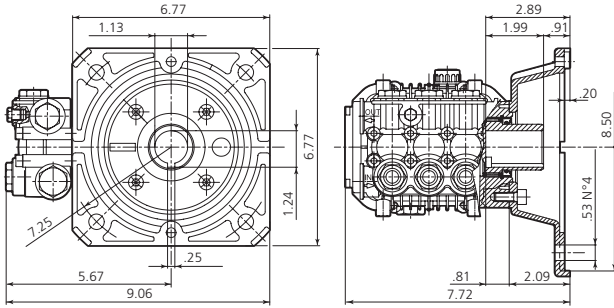

SXMV

D version + F24
Hollow shaft pump \varnothing 1"

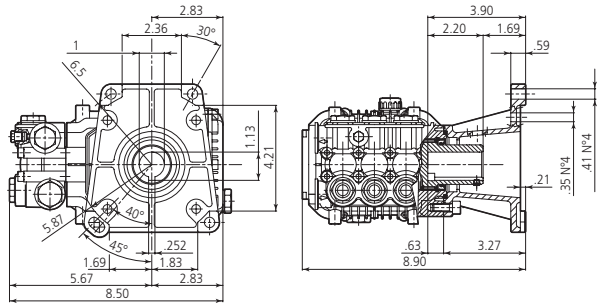

SXW / SXWA

N version
Solid shaft pump \varnothing 24 mm

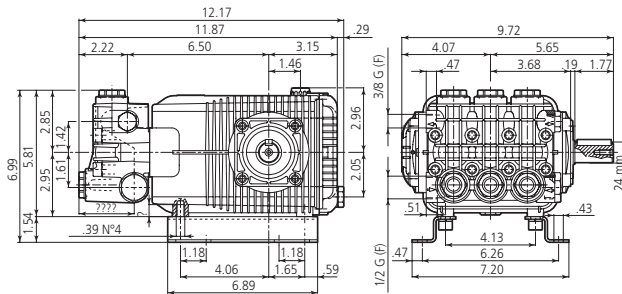

SPRAY NOZZLE CHART

Nozzle #	1000	1200	1400	1600	1800	2000	2200	2400	2600	2800	3000	3200	3400	3600	3700	4000	4200	4400	4600	4800	5000	
	PSI	PSI	PSI	PSI	PSI	PSI	PSI	PSI	PSI	PSI	PSI	PSI	PSI	PSI	PSI	PSI	PSI	PSI	PSI	PSI	PSI	PSI
2.0	1.00	1.10	1.18	1.26	1.34	1.41	1.48	1.55	1.61	1.67	1.73	1.79	1.84	1.90	1.92	2.00	2.05	2.10	2.14	2.19	2.40	
2.25	1.13	1.23	1.33	1.42	1.51	1.59	1.67	1.74	1.81	1.88	1.95	2.01	2.07	2.13	2.16	2.25	2.31	2.36	2.41	2.46	2.52	
2.5	1.25	1.37	1.48	1.58	1.68	1.77	1.85	1.94	2.02	2.09	2.17	2.24	2.30	2.37	2.40	2.50	2.56	2.62	2.68	2.74	2.80	
2.75	1.38	1.51	1.63	1.74	1.84	1.94	2.04	2.13	2.22	2.30	2.38	2.46	2.54	2.61	2.64	2.75	2.82	2.88	2.95	3.01	3.07	
3.0	1.50	1.64	1.77	1.90	2.01	2.12	2.22	2.32	2.42	2.51	2.60	2.68	2.77	2.85	2.89	3.00	3.07	3.15	3.22	3.29	3.35	
3.25	1.63	1.78	1.92	2.06	2.18	2.30	2.41	2.52	2.62	2.72	2.81	2.91	3.00	3.08	3.13	3.25	3.33	3.41	3.49	3.56	3.63	
3.5	1.75	1.92	2.07	2.21	2.35	2.47	2.60	2.71	2.82	2.93	3.03	3.13	3.23	3.32	3.37	3.50	3.59	3.67	3.75	3.83	3.91	
4.0	2.00	2.19	2.37	2.53	2.68	2.83	2.97	3.10	3.22	3.35	3.46	3.58	3.69	3.79	3.85	4.00	4.10	4.20	4.29	4.38	4.47	
4.5	2.25	2.46	2.66	2.85	3.02	3.18	3.34	3.49	3.63	3.76	3.90	4.02	4.15	4.27	4.33	4.50	4.61	4.72	4.83	4.93	5.03	
5.0	2.50	2.74	2.96	3.16	3.35	3.54	3.71	3.87	4.03	4.18	4.33	4.47	4.61	4.74	4.81	5.00	5.12	5.24	5.36	5.48	5.59	
5.5	2.75	3.01	3.25	3.48	3.69	3.89	4.08	4.26	4.43	4.60	4.76	4.92	5.07	5.22	5.29	5.50	5.64	5.77	5.90	6.02	6.15	
6.0	3.00	3.29	3.55	3.79	4.02	4.24	4.45	4.65	4.84	5.02	5.20	5.37	5.53	5.69	5.77	6.00	6.15	6.29	6.43	6.57	6.71	
6.5	3.25	3.56	3.85	4.11	4.36	4.60	4.82	5.03	5.24	5.44	5.63	5.81	5.99	6.17	6.25	6.50	6.66	6.82	6.97	7.12	7.27	
7.0	3.50	3.83	4.14	4.43	4.70	4.95	5.19	5.42	5.64	5.86	6.06	6.26	6.45	6.64	6.73	7.00	7.17	7.34	7.51	7.67	7.83	
7.5	3.75	4.11	4.44	4.74	5.03	5.30	5.56	5.81	6.05	6.27	6.50	6.71	6.91	7.12	7.21	7.50	7.69	7.87	8.04	8.22	8.39	
8.0	4.00	4.38	4.73	5.06	5.37	5.66	5.93	6.20	6.45	6.69	6.93	7.16	7.38	7.59	7.69	8.00	8.20	8.39	8.58	8.76	8.94	
8.5	4.25	4.66	5.03	5.38	5.70	6.01	6.30	6.58	6.85	7.11	7.36	7.60	7.84	8.06	8.18	8.50	8.71	8.91	9.12	9.31	9.50	
9.0	4.50	4.93	5.32	5.69	6.04	6.36	6.67	6.97	7.26	7.53	7.79	8.03	8.30	8.54	8.66	9.00	9.22	9.44	9.65	9.86	10.06	
9.5	4.75	5.20	5.62	6.01	6.37	6.72	7.05	7.36	7.66	7.95	8.23	8.50	8.76	9.01	9.14	9.50	9.73	9.96	10.19	10.41	10.62	
10.0	5.00	5.48	5.92	6.32	6.71	7.07	7.42	7.75	8.06	8.37	8.66	8.94	9.22	9.49	9.62	10.00	10.25	10.49	10.72	10.95	11.18	
11.0	5.50	6.02	6.51	6.96	7.38	7.78	8.16	8.52	8.87	9.20	9.53	9.84	10.14	10.44	10.58	11.00	11.27	11.54	11.80	12.05	12.30	
12.0	6.00	6.57	7.10	7.59	8.05	8.49	8.90	9.30	9.67	10.04	10.39	10.73	11.06	11.38	11.54	12.00	12.30	12.59	12.87	13.15	13.42	
12.5	6.25	6.85	7.40	7.91	8.39	8.84	9.27	9.68	10.08	10.46	10.83	11.18	11.52	11.86	12.02	12.50	12.81	13.11	13.40	13.69	13.98	
13.0	6.50	7.12	7.69	8.22	8.72	9.19	9.64	10.07	10.48	10.88	11.26	11.63	11.99	12.33	12.50	13.00	13.32	13.63	13.94	14.24	14.53	

Gallons Per Minute



Plunger Pumps

Formulas

Nozzles:

Impact Force (lbs.) = .0526 x GPM x $\sqrt{\text{PSI}}$

Nozzle # = GPM x $\frac{4000}{\sqrt{\text{PSI}}}$

GPM = Nozzle # x $\frac{\text{PSI}}{\sqrt{4000}}$

PSI = (GPM/Nozzle #)² x 4000

Horse Power:

$\frac{\text{GPM} \times \text{PSI}}{1714}$ = Hydraulic HP

$\frac{\text{GPM} \times \text{PSI}}{1457}$ = EBHP

$\frac{\text{EBHP} \times 1457}{\text{PSI}}$ = GPM

$\frac{\text{EBHP} \times 1457}{\text{GPM}}$ = PSI

HP loss due to altitude = 3% per 1000 FT above sea level

Pump Speed and Flow:

Rated GPM = $\frac{\text{Desired GPM}}{\text{Rated RPM}}$

Desired RPM = $\frac{\text{Rated RPM}}{\text{Desired GPM}}$

Motor Pulley \varnothing = $\frac{\text{Pump Pulley } \varnothing}{\text{Pump RPM}} \times \text{Motor RPM}$

Conversions

Gallons x 3.785412 = Liters

Gallons x 128 = Oz.

PSI x .06896 = Bar

Bar x 14.5038 = PSI

1 inches = 25.4 millimeters

Liters x .2642 = Gallons (US)

Ft. Lbs. x 1.356 = Newton Meters

Inch Lbs. x .11298 = Newton Meters

Newton Meters x .737562 = Ft. Lbs. (force)

Newton Meters x 8.85 = In. Lbs. (force)

Temperature = 1.8(C° + 17.78) = F°, .555(F° - 32) = C°

1 U.S. Gallon of freshwater = 8.33 lbs.

1 PSI = 2.31 feet of water

1 PSI = 2.04 inches of mercury

1 Foot of water = .433 PSI

1 Foot of water = .885 inches of mercury

1 Meter of water = 3.28 feet of water

Kilograms x 2.2 = Lbs.



General Safety Information

⚠ WARNINGS

Gasoline Drive Pumps

 The pump is designed to pump non-flammable or non-explosive fluids. These pumps are intended to pump clean filtered water only.

 Do not operate in or around an explosive environment.

  Always wear safety glasses or goggles and appropriate clothing.

 Do not alter the pump from the manufacturers design.

 Do not allow children to operate the pump.

 Never point the high-pressure discharge at a person, any part of the body or animals.

Do not operate gasoline engines in a confined area; always have adequate ventilation.

 Do not exceed the pump specifications in speed or pressure.

Plunger Pumps

General Safety Information (continued)

 Maximum water temperature is 140°F.

All positive displacement plunger pumps must have a safety relief valve installed on the discharge side of the pump, this valve could be either an unloader or regulator and must be of adequate flow and pressure for the pump.

Adequate protective guards must cover all moving parts. Perform routine maintenance on the pump and components.

Use only components that are rated for the flow and pressure of the pump, this would include hose, fittings, safety valves, spray guns etc.

Electric Drive Pumps

Your power supply must conform to the system requirements.

 The motor must be grounded. Use GFCI plugs and receivers.

 Do not handle the pump/motor with wet hands.

 Only use power cords that are in good condition.

 Never pull the unit by the power cord.

Never spray or clean the unit with water

Failure to follow these warnings may result in personal injury or damage to property.

Special Features

Wet End

Manifold: Forged Brass: Strength and no porosity equals long life. Higher hydrostatic pressures, safety and performance. **Inlet and Discharge Ports:** Heavy bosses for added strength. **Offset Discharge Ports:** High efficiency, smooth flow. **Bolts:** Eight bolts, 6mm, grade 12.9.

Valves: Ultra Form Cages: Durability, strength and long life. Poppets, **Seat and Spring:** 303 and 400 series stainless steel. **Valve Caps:** Machined brass – greater strength.

Packing and Plungers: High Pressure Packing: “V” style (D-1) Buna-N (cotton duct weave base) strong and tightens under load. **Low Pressure Seals:** “U” cup double lip Buna-N, good positive seal. **Support Guides:** Machined brass, two-piece construction to assure proper plunger alignment and to maximize packing and seal life. **Plungers:** Are a special aluminum oxide blend, solid ceramic for long life, strong durability and more resilient.

Drive End

Bearings: Oversized for maximum life and load disbursement, needle bearing on the drive side and ball on the non-drive side. Each bearing is held in position on the crankshaft and crankcase by snap rings. This assures positive alignment and centering of the connecting rods and crankshaft in relation to the crankcase, it also eliminates the crankshaft from floating.

Plunger Pumps

Special Features (continued)

Crankcase: Precision die-cast, large cooling fins and anodized (for maximum heat dissipation).

Rear Cover: precision die-cast, O-ring sealed and bayonet style sight glass for positive sealing and locking (no threads to loosen).

Plunger Rods: Stainless steel construction for strength (no plating to scrape off). O-ring plunger sealing system.

Rod Pins: Precision ground and hardened steel, oversized for load disbursement.

Connecting Rods: One-piece special alloy aluminum based, oversized for maximum strength, load disbursement, and life. Heavy pin area construction, for added load strength.

Crankshaft: Forged, precision ground and hardened for extremely long life and durability.

Oil Seals and O-rings: All are constructed of Buna-N rubber. The O-rings have stainless steel garter springs to assure constant tension on the sealing surface.

Oil Capacity: 14.5 oz., refer to parts breakdown.

Extra Features

Dyno Proven: All pumps are dyno tested to assure the theoretical design meets the actual design.

Valve Design: Each pump series has a valve design that optimizes its highest efficiency.

Hot Water: High temperature kits are

available to 180° F. Refer to breakdown

Wet End Repair: Very simple no special tools are required.

Mounting Bolt Pattern: Same on the top and bottom of the crankcase for simple drive side change.

Design: Using advanced fluid handling design programs. Overall pump efficiency is increased.

Installation

Direct Drive Gasoline Pumps

1. Install the shaft key into the keyway and apply a light coating of anti-seize on the engine shaft. (See Figure 4 & 5)
2. Align the two key ways and push the pump completely onto the engine.
3. Install all four (4) bolts and tighten evenly.
4. Remove the red shipping oil cap and install the black crankcase vent cap. (See Figure 6)
5. Install the appropriate unloader valve and other accessories.
6. Install the appropriate water inlet and discharge fittings.

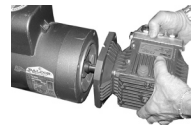

Figure 4

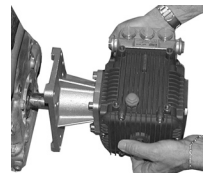

Figure 5

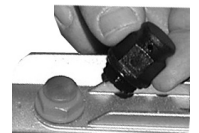

Figure 6

Plunger Pumps

Installation (continued)

7. Connect the water supply hose and high-pressure discharge hose/spray gun.
8. Turn on the water supply.
9. Open the spray gun to purge the system of any air.
10. Start the engine.
11. Adjust the engine speed and unloader valve.

Belt Drive Systems

1. Mount the pump securely to the base plate. (See Figure 7) For new installation a mounting rail kit is required, refer to parts breakdown.

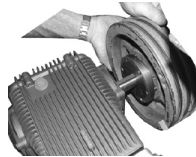

Figure 7

2. Install the pump pulley on the crankshaft. It should be as far onto the shaft as possible.



Figure 8

3. Align the pulleys so they are in line. (See Figure 8)

4. Use a belt tension gauge to assure proper tension (too much tension can cause bearing failure or damage the belts as well as cause other problems). (See Figure 9)

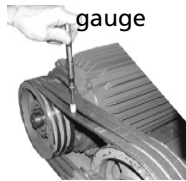

Figure 9

5. Installation complete.

Winter or Long Time Storage

1. Drain all of the water out of the pump.

2. Run a 50% solution of a RV or non-toxic/biodegradable antifreeze through the pump.
3. Flush the pump with fresh water before the next use.
4. In freezing conditions failure to do this may cause internal pump damage.
5. For long periods of storage in non-freezing areas the solution will keep the seals and O-rings lubricated.

Service Pumps

Servicing the Valves

The inlet and discharge valves in this series pumps are all the same. The valves are located under the six 21mm hex plugs. The inlet valves are located on the lower row and the discharge valves are located on the top row of the pump head.

Tools required: 21mm socket, ratchet, needle nose pliers, mechanics pick and torque wrench.

Valve Removal:

1. Remove the valve cap. (See Figure 10)
2. Inspect the valve cap O-ring for any damage, replace if necessary.
3. Use the needle nose pliers to remove the valve. (See Figure 11)

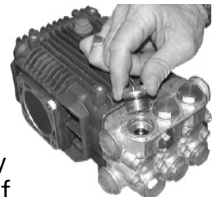

Figure 10

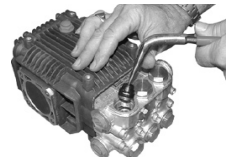

Figure 11

Plunger Pumps

Service Pumps (continued)

4. Use a small probe to move the poppet up and down to assure that the valve is functioning properly and that no debris is stuck in the valve. (See Figure 12)



Figure 12

5. Using the mechanics pick remove the valve seat O-ring and inspect for any damage, replace if necessary. (See Figure 13)



Figure 13

Valve Assembly:

1. Install the valve seat O-ring squarely into the bottom of the manifold. (See Figure 14)
2. Insert the valve assembly squarely into the port pushing it into the O-ring. (See Figure 15)
3. Install the valve cap and torque to the proper specification. (See Figure 16) (See parts breakdown)

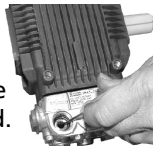

Figure 14



Figure 15



Figure 16

Servicing the Packings/Seals

To access the water seals for inspection or replacement, you will first need to remove the head of the pump.

Tools required: 5mm hex socket, ratchet, (2) long screwdrivers, reversible pliers, mechanics pick and torque wrench.

Disassembly:

1. First remove the eight 5mm head bolts. (See Figure 17)
2. Place the screwdrivers as shown between the head and crankcase of the pump, lifting one up and the other down. The head should start to lift off of the plungers. (See Figure 18)
3. When you remove the head you may notice that some of the water seals have stayed on the plungers and some in the head. To remove the seals from the plungers simple turn the assemblies and pull off. (See Figure 19)
4. If the seal assemblies are in the head use the reversible pliers to grab the seal retainer to the outside ring, twist the retainer in either direction (this is done to free the retainer O-ring which is stuck to the manifold) and lift out. (See Figure 20 & 21)



Figure 17



Figure 18



Figure 19



Figure 20



Figure 21

Plunger Pumps

Service Pumps (continued)

5. With your finger pull out the brass intermediate guide ring. (See Figure 22)



Figure 22

6. With your finger pull the high-pressure seal and head ring out of the head. (See Figure 23)



Figure 23

7. The low-pressure seal is located in the brass seal retainer. Using the mechanics pick, go in between the seal and retainer and pull the seal straight out. (See Figure 24)



Figure 24

8. Remove the seal retainer O-ring with the mechanics pick. (See Figure 25)



Figure 25

Assembly:

1. Install the plastic head ring into the head (the flat side is on the bottom) (See Figure 26)



Figure 26

2. Install the high-pressure seal. Place the seal so the open "V" portion is toward the head ring. You need to place the seal at an angle and pull and push to work the seal into position with your fingers (do not use any tools you may damage the seal). Make sure the seal is totally seated against the head ring. (See Figure 27 & 28)



Figure 27



Figure 28

3. Place the brass

intermediate ring squarely over the high-pressure seal. (See Figure 29)

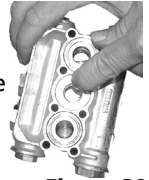

Figure 29

4. Installing the low-pressure seal with the closed flat side of the seal being pushed into the piston guide (when finished you should be looking at the open side of the seal). (See Figure 30)



5. Install the retainer O-ring. (See Figure 31)



Figure 31

6. Squarely seat the retainer into the head and push with even pressure until it snaps into position. (See Figure 32)



Figure 32

Servicing the Plungers

If the plungers are not damaged they do not need any servicing.

Tools required: 13mm socket, ratchet, mechanics pick, taper blade gasket scraper, thread sealant and torque wrench.

NOTE: Be very careful when working with the plungers, they are made from ceramic which is brittle and can be damaged.

Any time you remove a plunger it is recommended you replace the slinger washer, O-ring and top plunger washer. The washers are a cushion for the ceramic plunger and compress

Plunger Pumps

Service Pumps (continued)

when first used and the O-ring will take a set to create a seal and usually will not spring back to its original shape. By not replacing these parts you run the risk of breaking a plunger or having a water leak.

Disassembly:

1. Remove the plunger retainer nut. (See Figure 33)



Figure 33

2. Insert the gasket scraper between the copper washer and plunger to remove the washer. (See Figure 34)



Figure 34

3. Twist and pull the plunger off the plunger rod. (See Figure 35)



Figure 35

4. Remove the plunger rod O-ring seal with the mechanics pick. (See Figure 36)



Figure 36

5. Remove the brass slinger. At this point clean any thread locker that is left on the plunger rod and retaining nut threads. (See Figure 37)



Figure 37

Assembly:

1. Install the brass slinger washer. (See Figure 38)

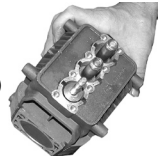

Figure 38

2. Install the plunger rod O-ring. Place a light film of oil on the O-ring. (See Figure 39)



Figure 39

3. Install the plunger by pushing straight down and twisting slightly in either direction. Make sure you fully seat the plunger. (See Figure 40)



Figure 40

4. Install the small copper washer on top of the plunger and place a small quantity of thread sealant in the thread. Install the plunger nut and tighten to the required torque. (See Figure 41) (See parts breakdown)



Figure 41

Pump Head to Drive End Installation

1. Turn the crankshaft to align the plungers as shown. (See Figure 42)



Figure 42

2. Place the head evenly onto the plungers and push it until it makes contact with the drive end of the pump. (See Figure 43)



Figure 43

Plunger Pumps

Service Pumps (continued)

3. Torque the head bolt as shown in the tightening sequence diagram. (See Figure 44 & 45) (See parts breakdown)



Figure 44

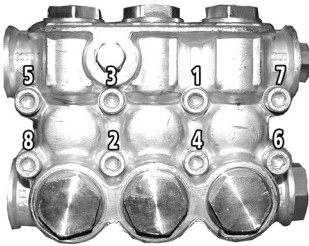

Figure 45

Oil Change

Change oil after first 50 hours of use. Then every 500 hours. Refer to parts breakdown for oil type.

Troubleshooting

Symptom	Possible Cause(s)	Corrective Action
Oil leak between crankcase and pumping section	Worn rod oil seals	Replace crankcase piston rod seals
Frequent or premature failure of the packing	1 Cracked, damaged or worn plunger	1 Replace plungers
	2 Overpressure to inlet manifold	2 Reduce inlet pressure
	3 Material in the fluid being pumped	3 Install proper filtration on pump inlet plumbing
	4 Excessive pressure and/or temperature of fluid being pumped	4 Check pressures and fluid inlet temperature; be sure they are within specified range
	5 Running pump dry	5 Do not run pump without water
Pump runs but produces no flow	Pump is not primed	Flood suction then restart pump
Pump fails to prime	Air is trapped inside pump	Disconnect discharge hose from pump. Flood suction hose, restart pump and run pump until all air has been evacuated
Pump loses prime, chattering noise, pressure fluctuates	1 Air leak in suction hose or inlet	1 Remove suction line and inspect it for a loose liner or debris lodged in hose. Avoid all unnecessary bends. Do not kink hose
	2 Clogged suction strainer	2 Clean strainer
Low pressure at nozzle	1 Unloader valve is by-passing	1 Make sure unloader is adjusted properly and by-pass seat is not leaking
	2 Incorrect or worn nozzle	2 Make sure nozzle is matched to the flow and pressure of the pump. If the nozzle is worn, replace
	3 Worn packing or valves	3 Replace packing or valves
Pressure gauge fluctuates	1 Valves worn or blocked by foreign bodies	1 Clean or replace valves
	2 Packing worn	2 Replace packing
Low pressure	1 Worn nozzle	1 Replace with nozzle of proper size
	2 Belt slippage	2 Tighten or replace with correct belt

Troubleshooting (cont.)

Symptom	Possible Cause(s)	Corrective Action
Low pressure (cont.)	3 Air leak in inlet plumbing	3 Disassemble, reseal and reassemble
	4 Relief valve stuck, partially plugged or improperly adjusted valve seat worn	4 Clean and adjust relief valve; check for worn or dirty valve seats
	5 Worn packing. Abrasive in pumped in cavitation. Inadequate water	5 Install proper filter suction at inlet manifold must be limited to lifting less than 20 feet of water or 8.5 psi vacuum
	6 Worn inlet, discharge valve blocked or dirty	6 Replace inlet and discharge valve
Pump runs extremely rough, pressure very low	1 Inlet restrictions and/or air leaks.	1 Clean out foreign material
	2 Stuck inlet or discharge valve	2 Replace worn valves
Water leakage from under manifold	Worn packing or cracked plunger	Install new packing or plunger
Slight leak, oil leaking in the area of crankshaft	1 Worn crankshaft seal or improperly installed oil seal o-ring	1 Remove oil seal retainer and replace damaged O-ring and/or seals
	2 Bad bearing	2 Replace bearing
Excessive play in the end of the crankshaft pulley	Worn main bearing from excessive tension on drive belt	Replace crankcase bearing and/or tension drive belt
Water in crankcase	1 Humid air condensing into water inside the crankcase	1 Change oil intervals
	2 Worn packing and/or cracked plunger	2 Replace packing. Replace plunger
Loud knocking noise in pump	1 Cavitation or sucking air	1 Check water supply is turned on
	2 Pulley loose on crankshaft	2 Check key and tighten set screw
	3 Broken or worn bearing	3 Replace bearing

SXMA 1750 RPM

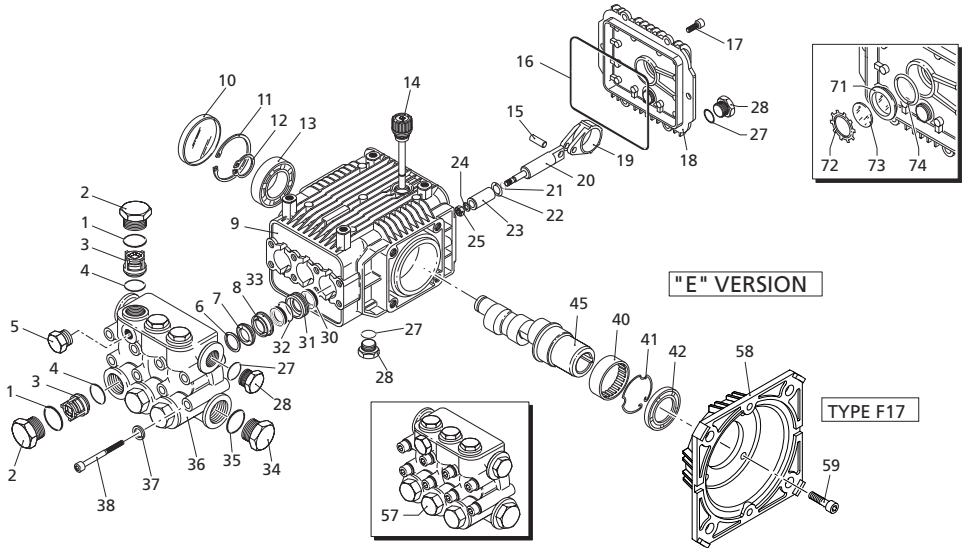

Repair Kits

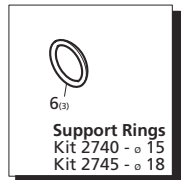
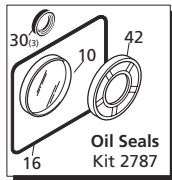
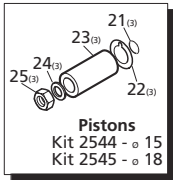
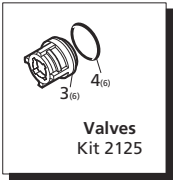

Special Parts / Kits

Code	Description	Qty.
2776	Viton water seals \varnothing 15	1
2777	Viton water seals \varnothing 18	1

Pos.	Code	Description	Qty.	Pos.	Code	Description	Qty.
1	960160	O-Ring $\phi 17.86 \times 2.62$	6	33	1260440	Low pressure seal $\phi 15 \text{ } \triangle$	3
2	1260162	Valve cap (442 in/lbs)	6	33	1260450	Low pressure seal $\phi 18 \bullet$	3
	1260162T	Valve Cap 1/4" threaded (442 in/lbs)	1	34	820361	Plug 1/2" G	1
3	1269050	Complete valve	6	35	180101	O-Ring $\phi 17.5 \times 2$	1
4	880830	O-Ring $\phi 15.54 \times 2.62$	6	36	1780020	Pump head	1
5	620301	Plug 1/8" G	1	37	1381550	Washer	8
6	1780130	Support ring $\phi 15 \text{ } \triangle$	3	38	1322730	Head bolt M6x60 (133 in/lbs)	8
	1780140	Support ring $\phi 18 \bullet$	3	40	1321190	Bearing	1
7	1260130	High pressure packing $\phi 15 \text{ } \triangle$	3	41	1321080	Snap ring	1
	1260220	High pressure packing $\phi 18 \bullet$	3	42	480671	Oil seal	1
8	1780090	Piston guide $\phi 15 \text{ } \triangle$	3	45	1780290	Hollow shaft $\phi 1-1/8"$	\triangle 1
	1780110	Piston guide $\phi 18 \bullet$	3		1780300	Hollow shaft $\phi 1-1/8"$	\circ 1
9	1780010	Pump body	1		1780950	Hollow shaft $\phi 1-1/8"$	\bullet 1
10	1266740	Cap	1	46	1380520	Key	1
11	1260790	Circlip $\phi i52$	1	47	1260750	Seal	1
12	1780550	Snap ring	1	57	1789201	Complete pump head \triangle	1
13	1780490	Bearing	1		1789202	Complete pump head \bullet	1
14	880130	Vented oil cap	1	58	1591	Motor Flange	1
15	1780050	Piston pin	3	59	180030	Bolt M8x20	4
16	1780510	O-Ring	1	71	1260250	Oil sight glass	1
17	1200430	Bolt M6x16 (89 in/lbs)	6	72	1260430	Snap ring	1
18	1789010	Crankcase cover	1	73	1780690	Contrast disc	1
19	1780710	Con rod - Bronze	3	74	1140450	O-Ring $\phi 20.24 \times 2.62$	1
20	1780060	Guiding piston	3		AR64516	Oil	1
21	480480	O-Ring $\phi 4.48 \times 1.78$	3			<i>OIL CAPACITY - 14.6 OZ</i>	
22	1260091	Washer (slinger)	3				
23	1780070	Plunger $\phi 15 \text{ } \triangle$	3				
	1780080	Plunger $\phi 18 \bullet$	3				
24	1260100	Piston washer	3				
25	1260110	Nut M8 (106 in/lbs)	3				
27	740290	O-Ring $\phi 14 \times 1.78$	3				
28	1980740	Plug 3/8" G	3				
30	1260460	Oil seal	3				
31	1780100	Rear piston guide $\phi 15 \text{ } \triangle$	3				
	1780120	Rear piston guide $\phi 18 \bullet$	3				
32	770260	O-Ring $\phi 23.52 \times 1.78$	3				

Legend

$\phi 15$

For \triangle
SXMA3G30
SXMA3G35

$\phi 15$

For \triangle
SXMA3.5G30

$\phi 18$

For \bullet
SXMA4G30



SX MV 3400 RPM

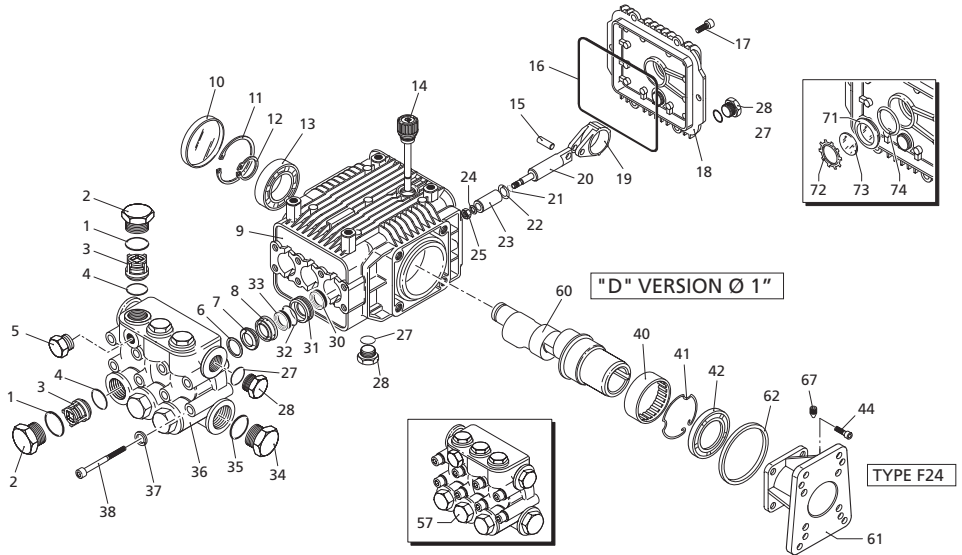

Repair Kits

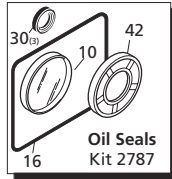
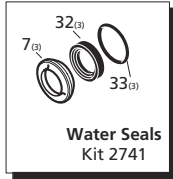
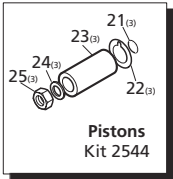
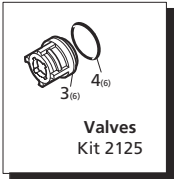

Special Parts / Kits

Code	Description	Qty.
2776	Viton water seals $\phi 15$	1
2817	Kit for up to 180° F $\phi 15$ High Temp	1

Pos.	Code	Description	Qty.	Pos.	Code	Description	Qty.
1	960160	O-Ring ϕ 17.86x2.62	6	40	1321190	Bearing	1
2	1260162	Valve cap (442 in/lbs)	6	41	1321080	Snap ring	1
3	1260162T	Valve Cap 1/4" threaded (442 in/lbs)	1	42	480671	Oil seal	1
3	1269050	Complete valve	6	44	180030	Bolt M8x20	4
4	880833	O-Ring ϕ 15.54x2.62	6	57	1789209	Complete pump head	1
5	620301	Plug 1/8" G	1	60	1780340	Hollow shaft ϕ 1"	○ 1
6	1780130	Support ring	3	61	1780920	Hollow shaft ϕ 1"	△ 1
7	1260130	High pressure packing	3	62	1780330	Hollow shaft ϕ 1"	■ 1
8	1780090	Piston guide	3	61	1597	Gas engine flange	1
9	1780010	Pump body	1	62	1780430	Bushing	1
10	1266740	Cap	1	67	820440	Set screw	1
11	1260790	Circlip ϕ i52	1	71	1260250	Oil sight glass	1
12	1780550	Snap ring	1	72	1260430	Snap ring	1
13	1780490	Bearing	1	73	1780690	Contrast disc	1
14	880130	Oil cap	1	74	1140450	O-Ring ϕ 20.24x2.62	1
15	1780050	Piston pin	3				
16	1780510	O-Ring	1	AR64516	Oil		1
17	1200430	Bolt M6x16 (89 in/lbs)	6		<i>OIL CAPACITY - 14.6 OZ</i>		
18	1789010	Complete cover	1				
19	1780710	Con rod - Bronze	3				
20	1780060	Guiding piston	3				
21	480480	O-Ring ϕ 4.48x1.78	3				
22	1260091	Washer (slinger)	3				
23	1780070	Plunger	3				
24	1260100	Piston washer	3				
25	1260110	Nut M8 (106 in/lbs)	3				
27	740290	O-Ring ϕ 14x1.78	3				
28	1980740	Plug 3/8" G	3				
30	1260460	Oil seal	3				
31	1780100	Rear piston guide	3				
32	770260	O-Ring ϕ 23.52x1.78	3				
33	1260440	Low pressure seal	3				
34	820361	Plug 1/2" G - Brass	1				
35	180101	O-Ring ϕ 17.5x2	1				
36	1781060	Pump head - Brass	1				
37	1381550	Washer	8				
38	1322730	Head bolt M6x60 (133 in/lbs)	8				

Legend

ϕ 15

For ○
SXMV3G35
SXMV3G40

ϕ 15

For △
SXMV3.5G32
SXMV3.5G35
SXMV3.5G40

ϕ 15

For ■
SXMV4G35



SXW 1450 RPM

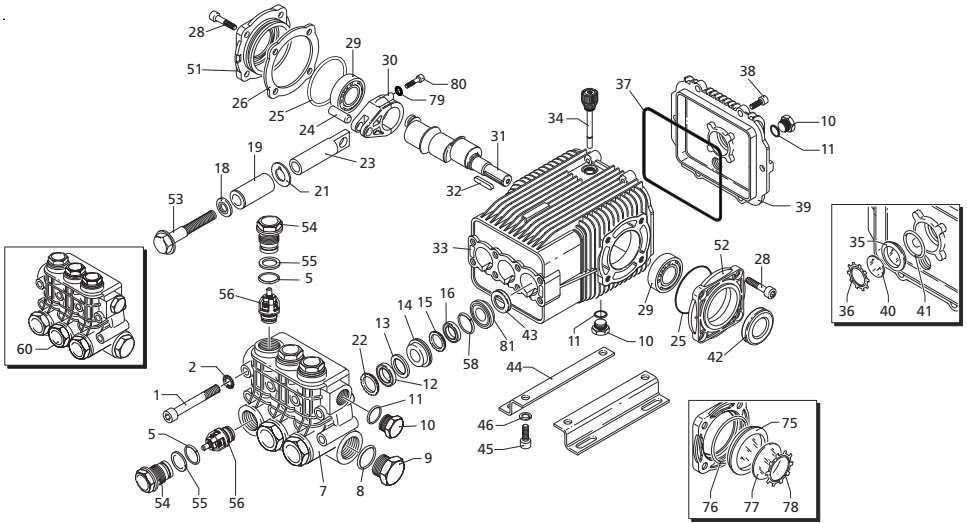

Repair Kits

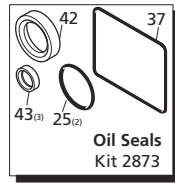
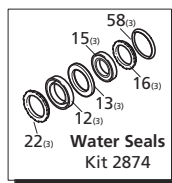
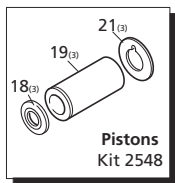

Special Parts / Kits

Code	Description	Qty.
2748	Rail kit 1-1/4" - 2 Rails - 4 Bolts - 4 Washers	1

Pos.	Code	Description	Qty.	Pos.	Code	Description	Qty.	
1	1940260	Head bolt M10x80	(442 in/lbs) 8	40	1780690	Sight glass back cover	1	
2	650530	Washer	8	41	1140450	O-Ring $\varnothing 20.24 \times 2.62$	1	
5	880830	O-Ring $\varnothing 15.54 \times 2.62$	6	42	820680	Seal	1	
7	1940930	Pump head	1	43	1940560	Oil seal	3	
8	180101	O-Ring $\varnothing 17.5 \times 2$	1	44	1940370	Base 1-1/4"	2	
9	820361	Plug 1/2" G	1	45	1940380	Bolt M10x18	4	
10	1980740	Plug 3/8" G	3	46	200231	Washer	4	
11	740290	O-Ring $\varnothing 14 \times 1.78$	3	51	1949011	Side cover w/sight glass	1	
12	1941200	High pressure packing	3	52	1941240	Open bearing support	1	
13	1941050	Support ring	3	53	1940920	Piston-fixing screw (62 in/lbs)	3	
14	1942470	Piston guide	3	54	1940940	Valve cap (531 in/lbs)	6	
15	1941350	Support ring	3	55	1941070	Back-up ring	6	
16	1941340	Low pressure seal	3	56	1949051	Complete valve	6	
18	1340600	Washer - Copper	3	58	820490	O-Ring $\varnothing 34.65 \times 1.78$	3	
19	1941020	Piston	3	75	1941270	Oil sight glass	1	
21	1383190	Slinger	3	76	100410	O-Ring $\varnothing 34.6 \times 2.62$	1	
22	1941190	Support ring	3	77	1941260	Contrast disc	1	
23	1940960	Guiding piston	3	78	1941290	Seal	1	
24	1940060	Con-rod pin	3	79	1380510	Con-rod bolt	6	
25	1941380	O-Ring $\varnothing 66.34 \times 2.62$	2	80	1381550	Lockwasher	6	
26	1941390	Shim 0.05 mm	1-3	81	1942480	Piston guide	3	
	1941400	Shim 0.10 mm	1-3					
	1941410	Shim 0.19 mm	1-3					
	1941420	Shim 0.25 mm	1-3					
28	850370	Bolt M 8x16	(217 in/lbs) 8					
29	1140410	Bearing	2					
30	1940050	Con rod	(89 in/lbs) 3					
31	1940980	Crankshaft 24mm	● 1					
	1940970	Crankshaft 24mm	○ 1					
32	650250	Key	1					
33	1941330	Pump housing	1					
34	1140370	Oil cap	1					
35	1260250	Oil sight glass	1					
36	1260430	Snap ring	1					
37	1940410	O-Ring $\varnothing 132 \times 3$	1					
38	1200430	Bolt M6x16	6					
39	1949010	Complete cover	1					

AR64516 Oil 2
OIL CAPACITY - 32 OZ

Legend

Ø 18

For ●
SXW15.35

Ø 18

For ○
SXW21.35

SXWA 1750 RPM

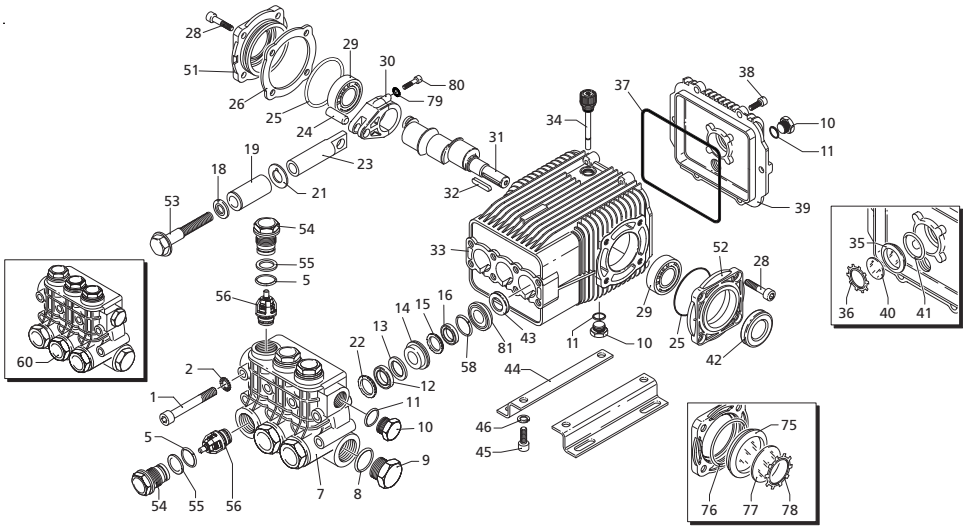

Repair Kits

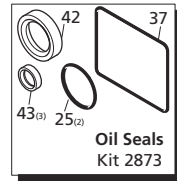
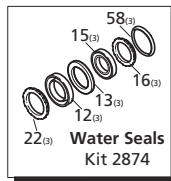
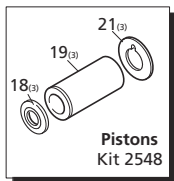

Special Parts / Kits

Code	Description	Qty.
2748	Rail kit 1-1/4" - 2 Rails - 4 Bolts - 4 Washers	1

Pos.	Code	Description	Qty.	Pos.	Code	Description	Qty.
1	1940260	Head bolt M10x80	(442 in/lbs) 8	39	1949010	Complete cover	1
2	650530	Washer	8	40	1780690	Sight glass back cover	1
5	880830	O-Ring ϕ 15.54x2.62	6	41	1140450	O-Ring ϕ 20.24x2.62	1
7	1940930	Pump head	1	42	820680	Seal	1
8	180101	O-Ring ϕ 17.5x2	1	43	1940560	Seal	3
9	820361	Plug 1/2" G	1	44	1940370	Base 1-1/4"	2
10	1980740	Plug 3/8" G	3	45	1940380	Bolt M10x18	4
11	740290	O-Ring ϕ 14x1.78	3	46	200231	Washer	4
12	1941200	High pressure packing	3	51	1949011	Side cover w/sight glass	1
13	1941050	Back-up ring	3	52	1941240	Open bearing support	1
14	1942470	Piston guide	3	53	1940920	Piston-fixing screw	(62 in/lbs) 3
15	1941350	Support ring	3	54	1940940	Valve cap	(531 in/lbs) 6
16	1941340	Low pressure seal	3	55	1941070	Back-up ring	6
18	1340600	Washer - Copper	3	56	1949051	Complete valve	6
19	1941020	Piston	3	58	820490	O-Ring ϕ 34.65x1.78	3
21	1383190	Slinger	3	75	1941270	Oil sight glass	1
22	1941190	Support ring	3	76	100410	O-Ring ϕ 34.6x2.62	1
23	1940960	Guiding piston	3	77	1941260	Contrast disc	1
24	1940060	Con-rod pin	3	78	1941290	Seal	1
25	1941380	O-Ring ϕ 66.34x2.62	2	79	1380510	Con-rod bolt	6
26	1941390	Shim 0.05 mm	1-3	80	1381550	Lockwasher	6
	1941400	Shim 0.10 mm	1-3	81	1942480	Piston guide	3
	1941410	Shim 0.19 mm	1-3				
	1941420	Shim 0.25 mm	1-3				
28	850370	Bolt M8x16	(217 in/lbs) 8				
29	1140410	Bearing	2				
30	1940050	Con rod	(89 in/lbs) 3	AR64516	Oil	2	
31	1940520	Crankshaft 24mm	● 1				
	1940170	Crankshaft 24mm	○ 1				
	1940970	Crankshaft 24mm	▲ 1				
32	650250	Key	1				
33	1941330	Pump housing	1				
34	1140370	Oil cap	1				
35	1260250	Oil sight glass	1				
36	1260430	Snap ring	1				
37	1940410	O-Ring ϕ 132x3	1				
38	1200430	Bolt M6x16	(89 in/lbs) 6				

OIL CAPACITY - 32 OZ

Legend

Ø 20	Ø 20	Ø 20
For ●	For ○	For ▲
SXWA4G50	SXWA5.5G50	SXWA7G50

Plunger Pumps

Torque Specifications in/lbs:(ft/lbs)

	Oil Capacity	Manifold (Head)	Piston Nut	Rear Cover	Side Cover	Valve Cap	Connecting Rods
SX	14	133/(11)	106/(8.8)	89/(7.5)	N/A	442/(37)	N/A

LIMITED WARRANTY

Annovi Reverberi (A.R.) *Cam Shaft Plunger Pumps* are warranted for a period of five years and *Axial Radial Pumps* are warranted for a period of one year to the original purchaser. *Electric Pressure Washers* are warranted for a period of one year to the original purchaser. This is from the date shipped from factory or U.S. Warehouse. **AR, ArrowLine** and **GF** accessories are warranted for a period of 90 days.

Warranty covers manufacturing defects or workmanship that may develop under normal use and service in a manner up to the directions and usage recommended by the manufacturer.

Warranty does not apply to misuse or when pump or accessory is altered or used in excess of recommended speeds, pressures, temperatures or handling fluids not suitable for pump or accessory material construction. Warranty does not apply to normal wear, freight damage, freezing damage or damage caused by parts or accessories not supplied by AR North America, Inc.

Liability of manufacturer for warranty is limited to repair or replacement at the option of the manufacturer when such products are found to be of original defect or workmanship at the time it was shipped from factory. This warranty is in lieu of all other warranties, expressed or implied, including any warranty of merchantability and of any and all other obligations or liabilities on the part of the manufacturers or equipment.

WARRANTY RETURNS

Items returned for warranty consideration must have a **Returned Merchandise Authorization (RMA)** number. All unauthorized returns will be refused and shipped back to sender. Please fax requests to: 763-398-2009 or e-mail to shop@arnorthamerica.com.