

REMINGTON®

8' ELECTRIC TELESCOPING POLE SAW

OWNER'S MANUAL

MODELS RPS 96: 104317, 106821

IMPORTANT: Read and understand this manual before assembling or operating this chain saw. Improper use of saw can cause severe injury. Keep this manual for future reference.



INTRODUCTION

Your Remington Telescoping Pole Saw is a dual purpose product. The electric chain saw is a separate operating unit when not assembled to the telescoping pole. Before operating either the chain saw or the Pole Saw, make certain you read and understand all *Important Safety Information*.

IMPORTANT SAFETY INFORMATION

⚠ WARNING: When using an electric chain saw, basic safety precautions should always be followed to reduce the risk of fire, electric shock, and injury to persons, including the following:

READ ALL INSTRUCTIONS.

Make sure you read and understand all instructions in *Important Safety Information* on pages 2 through 4. Improper use of this chain saw can cause severe injury or death from fire, electrical shock, body contact with moving chain, or falling wood.

BEFORE OPERATING SAW

1. Read and understand both chain saw and Pole Saw manuals before operating saws.
2. Watch what you are doing. Use common sense. Do not operate saw when you are tired.
3. Use chain saw for cutting wood only. Do not use chain saw for purpose not intended. Do not use for cutting non-wood items.
4. Only well-instructed adults should operate Pole Saw or chain saw. Never allow children to operate chain saw.
5. Use only electrical voltage noted on model plate of chain saw.
6. Use only extension cords marked for outdoor use. See *Operating Chain Saw* section of chain saw manual for extension cord requirements.
7. Do not operate Pole Saw or chain saw
 - while under the influence of alcohol, medication, or drugs
 - in rain or in damp or wet areas
 - where highly flammable liquids or gases are present
 - if pole or saw is damaged, adjusted wrong, or not fully and securely assembled
 - if trigger does not turn saw on and off. Chain must stop moving when you release trigger. Have faulty switch replaced by authorized service center (see *Technical Service*, page 16).
 - while in a hurry
 - while in tree or on a ladder
 - while on aerial booms, buckets or platforms

8. Wear snug-fitting clothes when operating Pole Saw or chain saw. Do not wear loose clothing or jewelry. They can get caught in moving saw chain.
9. Wear the following safety gear when operating saws:
 - heavy-duty gloves (wear rubber gloves when working outdoors)
 - steel-toed safety footwear with non-skid soles
 - eye protection such as safety glasses, goggles, or face screen
 - safety hard hat
 - ear muffers or ear plugs
 - hair covering to contain long hair
 - face or dust mask (if working in dusty areas)
10. Before cutting, always provide the following:
 - clear work area
 - secure footing
 - planned retreat path from falling limbs
11. Inspect tree before trimming. Make allowance for branches to fall freely to the ground.
12. Do not use your Pole Saw to fell saplings. Use the chain saw without pole attachment.
13. To reduce the risk of electric shock, this saw has a polarized plug (one blade is wider than the other). This plug will fit in a polarized outlet only one way. If the plug does not fit fully in the outlet of your extension cord, reverse the plug. If it still does not fit, a polarized extension cord will be necessary. Do not change the plug in any way.

WHILE OPERATING POLE SAW

1. Stay alert. Use common sense while operating the unit.
2. Keep work area clean. Cluttered areas invite injuries.
3. Be aware of extension cord while operating chain saw. Be careful not to trip over cord. Keep cord away from chain and operator at all times.
4. Keep children, animals, and bystanders away from Pole Saw and extension cord. Only Pole Saw user should be in work area.
5. Do not use the Pole Saw to cut down trees. Use the chain saw without pole attachment and only if you are trained or have expert help.
6. Do not use near power lines. Keep at least 10 feet away from electrical lines.
7. Grip Pole Saw securely - one hand on the pole, the other on the handle.
8. Keep finger off trigger until ready to make cut.
9. Before starting Pole Saw, make sure chain is not touching anything.
10. To guard against electrical shock, avoid body contact with grounded objects such as pipes, fences, and metal posts.
11. Keep all parts of body away from chain when saw is running.

IMPORTANT SAFETY INFORMATION

Continued

12. Do not force chain saw while cutting. Apply light pressure. It will do the job better and safer at the rate for which it was intended.
13. When cutting limb or tree trunk that is under tension, use extreme caution. Be alert for wood springing back. When wood tension is released, limb could spring back and strike operator causing severe injury or death.
14. Carry Pole Saw from one place to another
 - with unit unplugged
 - with telescoping pole returned to shortest position
 - by holding pole at balance point (close to saw end)
 - with guide bar and chain to rear
15. Do not cut small brush and saplings with the Pole Saw. Use the chain saw only, with extreme care. Slender matter may catch in the chain and be whipped toward you. This could also pull you off balance.

 **WARNING: This product contains chemicals known to the State of California to cause cancer or birth defects, or other reproductive harm.**

 **WARNING: Some dust created by power sanding, sawing, grinding, drilling, and other construction activities contains chemicals known (to the state of California) to cause cancer, birth defects, or other reproductive harm. Some examples of these chemicals are:**

- lead from lead-based paints
- crystalline silica from bricks and cement and other masonry products
- arsenic and chromium from chemically-treated lumber

Your risk from these exposures varies, depending on how often you do this type of work. To reduce your exposure to these chemicals: work in a well ventilated area, and work with approved safety equipment, such as those dust masks that are specially designed to filter out microscopic particles.

KICKBACK

 **WARNING: Kickback may occur when the nose or tip of the guide bar touches an object, or when the wood closes in and pinches the saw chain in the cut. Tip contact in some cases may cause a lightning fast reverse reaction, kicking the guide bar up and back towards the operator. Pinching the saw chain along the top of the guide bar may push the guide bar rapidly back towards the operator. Either of these reactions may cause you to lose control of the saw which could result in serious injury to user.**

Kickback Safety Devices On This Saw

This saw has a low-kickback chain and reduced kickback guide bar. Both items reduce the chance of kickback. Kickback can still occur with this saw.

The following steps will reduce the risk of kickback.

- Use both hands - one gripping the handle and the other gripping the pole. Use firm grip. Thumbs and fingers must wrap around pole and handle.
- Keep all safety items in place on saw. Make sure they work properly.
- Do not overreach or extend arms above shoulder height.
- Keep solid footing and balance at all times.
- Never try cutting through two branches at the same time. Only cut one at a time.
- Do not bury guide bar nose or try plunge cut (boring into wood using guide bar nose).
- Watch for shifting of wood or other forces that may pinch chain.
- Use extreme caution when reentering a previous cut.
- Use low-kickback chain and guide bar supplied with the chain saw. Only use replacement parts listed for the pole saw.
- Never use dull or loose chain. Keep chain sharp with proper tension.

Saw Maintenance and Kickback Safety

Follow maintenance instructions in the chain saw manual. Proper cleaning of saw and chain and guide bar maintenance can reduce chances of kickback. Inspect and maintain saw after each use. This will increase the service life of your saw. *Note:* Even with proper sharpening, risk of kickback can increase with each sharpening.

Continued

IMPORTANT SAFETY INFORMATION

Continued

MAINTENANCE AND STORAGE OF POLE SAW

Unplug Pole Saw from power source and follow maintenance and storage procedures outlined in the *Maintenance and Storage* section of your chain saw manual.

POLE SAW TRIMMING PRECAUTIONS

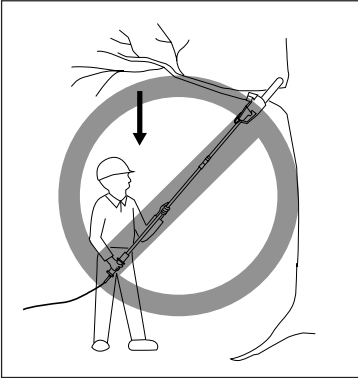

Never stand directly under the limb you are trimming. Always position yourself out of the path of falling debris.

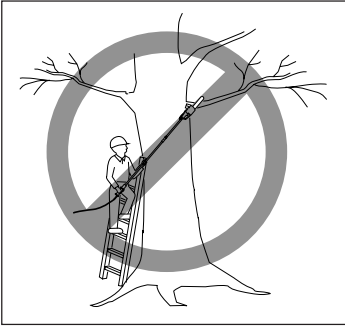

Never stand on a ladder or other type of unstable support while using the Pole Saw. Always use both hands to operate Pole Saw. Keep a firm, steady pressure on the Pole Saw while cutting but do not try to force the saw through the wood.

Do not use the Pole Saw to cut limbs larger in diameter than the length of the guide bar.

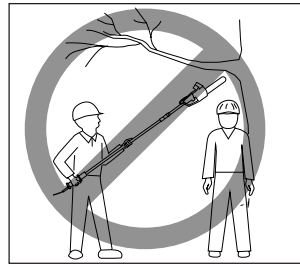

Keep other persons away from cutting end of polesaw and at a safe distance from work area.

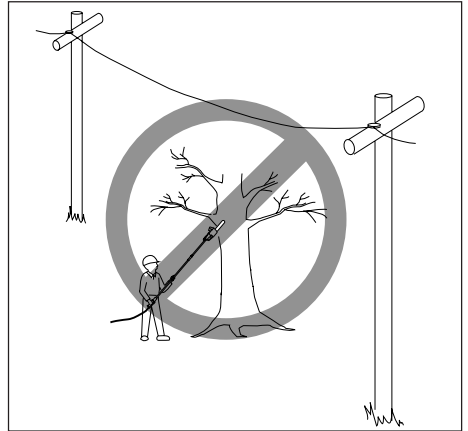

Do not use Pole Saw near cable, electric power or telephone lines. Maintain a minimum clearance of 10 feet from all power lines.

FIGURES

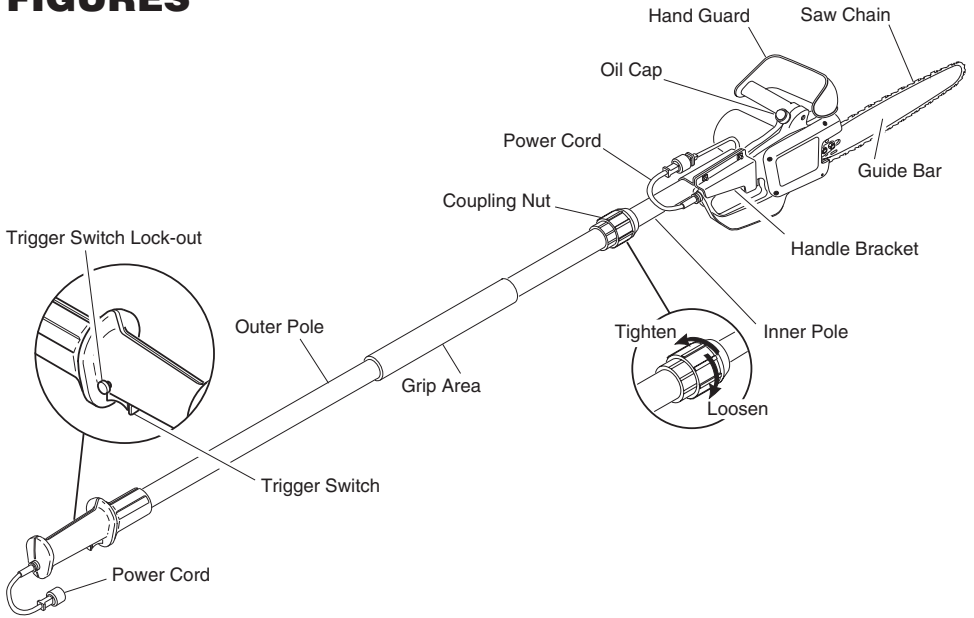

Figure 1 - Pole Saw Product Identification

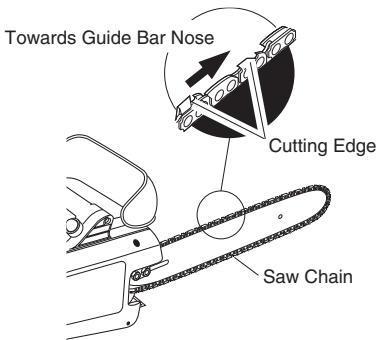

Figure 2 - Chain Position

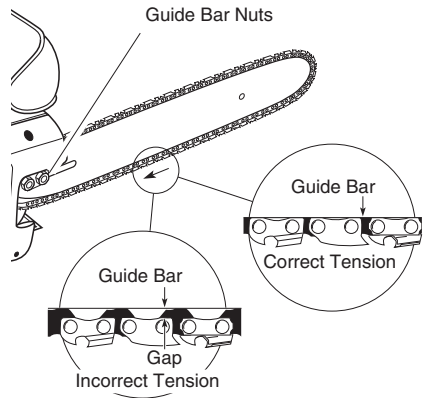

Figure 4 - Saw Chain Adjustment

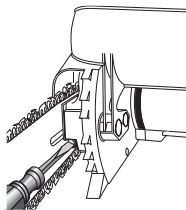

Figure 3 - Turning Adjusting Screw

FIGURES

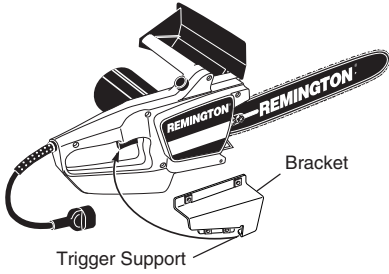

Figure 5 - Bracket with Trigger Support

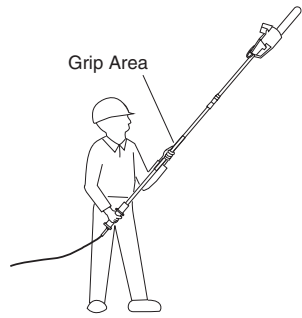

Figure 9 - Designated Grip Areas

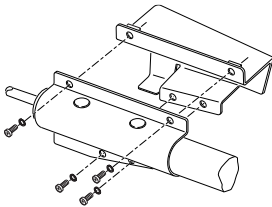

Figure 6 - Assembly of Pole Saw Brackets

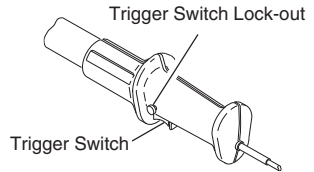

Figure 10 - Pole Saw Handle with Trigger Switch Lock-out

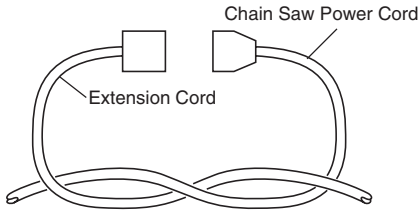

Figure 7 - Tying Extension Cord and Power Cord in Knot

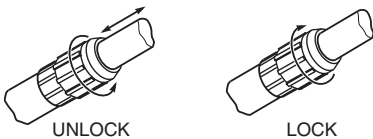

Figure 8 - Extending Telescopic Pole

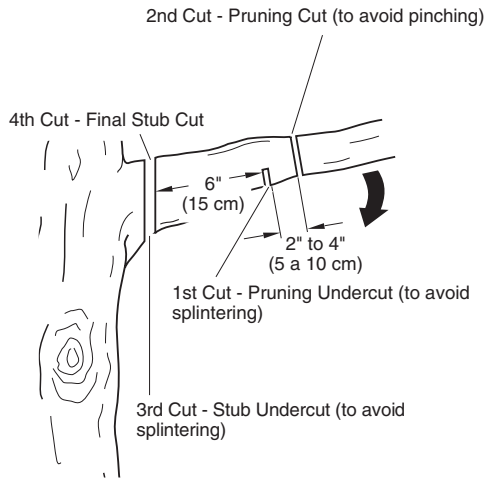

Figure 11 - Cutting A Limb

REMINGTON®

ELECTRIC CHAIN SAW

MODELS RPS 96: 104317, 106821

IMPORTANT: Read and understand this manual before assembling or operating this chain saw. Improper use of saw can cause severe injury. Keep this manual for future reference.

UNPACKING

1. Remove all items from carton.
2. Check all items for any shipping damage. If you find any damage or if any parts are missing, promptly inform dealer where you bought the Pole Saw.

POLE SAW NAMES AND TERMS

Coupling Nut Threaded collar (loosen to slide inner pole, tighten to hold pole in position).

Guide Bar Metal bar that extends from saw body. The guide bar supports and guides chain.

Inner Pole The moveable section of tubing to which the saw is attached.

Kickback Quick backward and upward motion of guide bar. Kickback may occur when tip of guide bar touches an object while chain is moving. The guide bar will kick up and back towards operator.

Oiler Control System for oiling guide bar and chain.

Outer Pole Retains the moveable inner pole.

Saw Chain (Chain) Loop of chain having cutting teeth for cutting wood. The motor drives chain. The guide bar supports chain.

Sprocket Toothed wheel that drives chain.

Switch Device that completes or interrupts electrical circuit to motor of saw.

Switch Lockout Device that reduces accidental starting of saw.

Trigger Device that turns saw on and off. Squeezing trigger turns saw on. Releasing trigger turns saw off.

Trimming (Pruning) Process of cutting limb(s) from a living tree.

Undercut An upward cut from underside of log or limb. This is done while in normal cutting position and cutting with top of guide bar.

ASSEMBLY

The plastic hardware bag for the Pole Saw should include the following:

CHAIN SAW HARDWARE

- (2) Guidebar bolts
- (2) Guidebar nuts
- (1) Phillips self tapping screw
- (1) Saw chain
- (1) Guide bar
- (1) Hand guard
- (1) Scabbard

POLE SAW HARDWARE

- (1) Handle bracket
- (4) #10 x 24 Phillips screws
- (4) #10 lockwashers

ASSEMBLY OF CHAIN SAW

Assemble the chain saw before assembling the pole. Refer to chain saw manual for assembly instructions.

⚠ CAUTION: Do not place chain on saw backwards. If chain is backwards, saw will vibrate badly and will not cut.

Make sure cutting edges of chain are facing in the right direction. Position chain so cutting edges on top of guide bar face guide bar nose (see Figure 2).

SAW CHAIN TENSION ADJUSTMENT

⚠ WARNING: Maintain proper chain tension always. A loose chain will increase the risk of kickback. A loose chain may jump out of guide bar groove. This may injure operator and damage chain. A loose chain will cause chain, guide bar, and sprocket to wear rapidly.

1. Before adjusting chain, make sure guide bar nuts are only finger tight (see Figure 4). Also make sure adjusting block is in oval adjusting hole on guide bar.
2. Turn adjusting screw clockwise until all slack is out of chain. *Note:* There should be no gap between side links of chain and bottom of guide bar.
3. Wearing protective gloves, move chain around guide bar. Chain should move freely. If chain does not move freely, loosen chain by turning adjusting screw counterclockwise.
4. After chain tension is correct, tighten guide bar nuts firmly. If not, guide bar will move and loosen chain tension. This will increase the risk of kickback. This can also damage saw. *Note:* A new chain will stretch. Check new chain after first few minutes of operation. Allow chain to cool down. Readjust chain tension.

ASSEMBLY

Continued

ASSEMBLY OF POLE SAW

1. Slip handle bracket over chain saw handle from the right side (see Figure 5). **Note:** The trigger must be depressed before the bracket will go onto the handle.
Push the lockout button and depress the trigger. While holding the trigger in, place the trigger support portion of the bracket under the trigger and slide the bracket onto the chain saw handle. The bracket will keep the trigger in the “on” position.
2. Align holes in pole bracket with holes in handle bracket. Install Phillips head screws with lockwashers through pole bracket from left side and thread into the weld nuts on the handle bracket. Tighten screws securely by hand.
3. Plug the saw power cord into receptacle cord at end of inner pole.

OPERATING CHAIN SAW

 **WARNING:** Read and understand this owner's manual before operating this Pole Saw. Make certain you read and understand all *Important Safety Information*, pages 2 through 4. Improper use of this Pole Saw can cause severe injury or death from fire, electrical shock, or body contact with moving chain, or falling wood.

EXTENSION CORDS

Use proper extension cords with this Pole Saw. Use only extension cords marked for outdoor use. The cord must be marked with suffix W or W-A following the cord type designation. *Example:* SJTW-A or SJTW. Use proper sized cord with this saw. Cord must be heavy enough to carry current needed. An undersized cord will cause voltage drop at saw. Saw will lose power and overheat. Follow cord size requirements listed below.

Cord Length	AWG Cord Size
25 feet	16 AWG
50 feet	16 AWG
100 feet	16 AWG
150 feet	14 AWG

Keep cord away from cutting area. Make sure cord does not catch on branches or logs during cutting. Inspect cords often. Replace damaged cords.

The extension cord may come undone from the power cord during use. To avoid this, make a knot with the two cords as shown in Figure 7.

ADJUSTING POLE LENGTH

The Remington Pole Saw has a telescoping pole assembly that will extend from 57 inches (fully retracted) to 96 inches (fully extended). A threaded compression coupling is used to hold the pole in position at any extended length.

1. To extend the pole, loosen coupling by turning coupling nut counterclockwise as shown in Figure 8. Pole will slide freely.
2. Pull inner pole section out to desired length of extension. **Note:** Only extend pole to minimum length required to reach limb that is being cut.
3. To lock pole in position, tighten coupling by turning coupling nut clockwise (see Figure 8) until firmly hand tight. Make sure saw handle is aligned with pole handle before tightening coupling nut. **IMPORTANT:** Do not use wrench or pliers to overtighten coupling. Damage to coupling or pole may result.

OILING CHAIN

Always check oil level before using saw. Do not attempt to operate the oil system while saw is in operation. To oil chain, press squeeze bulb. Oil will feed onto the guide bar and chain. Press squeeze bulb at least once before each cut. Check oil level often by looking at oil sight level hole. Oil sight level hole is on left side of saw, between front handle and front hand guard.

CUTTING WITH THE POLE SAW

1. Connect saw to extension cord. Connect extension cord to power supply.
2. Use both hands to grip Pole Saw. Use only designated grip areas when operating Pole Saw (see Figure 9). Use firm grip. Thumbs and fingers must wrap around Pole Saw handle and pole.
3. Make sure your footing is firm. Keep feet apart. Divide your weight evenly on both feet.
4. When ready to make a cut, press in trigger switch lock-out and squeeze trigger switch (see Figure 10). This will turn Pole Saw on. Releasing trigger switch will turn Pole Saw off. Make sure saw is running at full speed before starting a cut.
5. When starting a cut, place moving chain against wood. Hold Pole Saw firmly in place to avoid possible bouncing or skating (sideways movement) of saw.
6. Guide Pole Saw using light pressure. Do not force Pole Saw. The motor will overload and can burn out. It will do the job better and safer at the rate for which it was intended.
7. Remove Pole Saw from a cut with saw running at full speed. Stop Pole Saw by releasing trigger. Make sure chain has stopped before setting Pole Saw down.

Continued

OPERATING CHAIN SAW

Continued

TRIMMING A TREE (PRUNING)

⚠ WARNING: Avoid kickback. Kickback can result in severe injury or death. See *Kickback*, page 3, to avoid risk of kickback.

⚠ WARNING: Do not operate Pole Saw while

- in a tree
- on a ladder or any other unstable surface
- in any awkward position

You may lose control of Pole Saw causing severe injury.

⚠ WARNING: Do not extend arms above shoulders when using Pole Saw.

⚠ CAUTION: Seek professional help if facing conditions beyond your ability.

Trimming a tree is the process of cutting limbs from a living tree. Make sure your footing is firm. Keep feet apart. Divide your weight evenly on both feet. Follow directions below to trim a tree.

1. Make first cut six inches from tree trunk on underside of limb. Use top of guide bar to make this cut. Cut 1/3 through diameter of limb (see Figure 18).
2. Move two to four inches farther out on limb. Make second cut from above limb. Continue cut until you cut limb off.
3. Make third cut as close to tree trunk as possible on underside of limb stub. Use top of guide bar to make this cut. Cut 1/3 through diameter of stub.
4. Make fourth cut directly above third cut. Cut down to meet third cut. This will remove limb stub.

TECHNICAL SERVICE

You may have further questions about assembling, operating, or maintaining this product. If so, you can visit our Technical Service web site at www.desatech.com or contact our Technical Service Department at 1-800-858-8501 (English Only). You may also write to:

DESA Specialty Products™

P.O. Box 90004

Bowling Green, KY 42102-9004

ATTN: Technical Service Specialty Products

When contacting DESA Specialty Products™, have ready

- Your Name
- Your Address
- Your Phone Number
- Model Number of Product
- Date of Purchase (Include copy of receipt for written requests).

REPLACEMENT PARTS AND ACCESSORIES

⚠ WARNING: Use only replacement parts and accessories described in this manual. Use of other parts or accessories could damage saw or injure operator.

For original replacement parts and accessories, contact your nearest Authorized Dealer or Authorized Service Center for this product. If they can not supply the part or accessory, contact your nearest Parts Central listed on page 30. Each Authorized Dealer, Authorized Service Center, and Parts Central is independently owned and operated.

See pages 28 and 29 for an Illustrated Parts List.

If you need additional referral information, contact our Technical Service Department (see *Technical Service*). In Canada call 1-800-561-3372 for parts information.

REPAIR SERVICE

Note: Only use original replacement parts. This will protect your warranty coverage for parts replaced under warranty.

Each Authorized Service Center is independently owned and operated.

WARRANTY SERVICE

If product requires warranty service, return it to nearest Authorized Service Center. You must show proof of purchase. If faulty materials or workmanship caused damage, we will repair or replace product without charge. **Note:** Normal wear, misuse, abuse, neglect, or accidental damage is not covered under warranty.

NON-WARRANTY SERVICE

If product requires service, return it to nearest Authorized Service Center. Repairs will be billed to you at regular repair list prices.

For additional Service Center or warranty information, call 1-800-858-8501 or visit our Technical Service web site at www.desatech.com.

WARRANTY INFORMATION

Model _____
Date Purchased _____

ELECTRIC POLE SAW LIMITED WARRANTY

Always specify model and serial numbers when writing the factory.

We reserve the right to amend these specifications at any time without notice. The only warranty applicable is our standard written warranty. We make no other warranty, expressed or implied.

DESA Specialty Products™ warrants this electric chain saw and any parts thereof, to be free from defects in material and workmanship for one year (90 days for reconditioned unit) from the date of first purchase from an authorized dealer, provided that the product has been properly maintained and operated in accordance with all applicable instructions. The bill of sales or proof of purchase must be presented at the time a claim is made under this warranty.

This warranty is extended only to the original retail purchaser. This warranty covers only the parts and labor required to restore this chain saw to its proper operating condition. Warranty parts must be obtained through factory authorized dealers and service centers for this product. These dealers and service centers will provide original factory replacement parts. Failure to use original factory replacement parts voids this warranty.

This warranty does not cover commercial, industrial, or rental usage, nor does it apply to parts that are not in original condition because of normal wear and tear, or parts that fail or become damaged as a result of misuse, accident, lack of proper maintenance, tampering, or alteration. Travel, handling, transportation, and incidental costs associated with warranty repairs are not reimbursable under this warranty and are the responsibility of the owner.

To the full extent allowed by the law of the jurisdiction that governs the sale of the product, this express warranty excludes any and all other expressed warranties and limits the duration of any and all implied warranties, including warranties of merchantability and fitness for a particular purpose to one year from the date of first purchase, and DESA Specialty Products™ liability is hereby limited to the purchase price of the product and DESA Specialty Products™ shall not be liable for any other damages whatsoever including indirect, incidental, or consequential damages.

Some states do not allow limitation of how long an implied warranty lasts or an exclusion or limitation of incidental or consequential damages, so the above limitation of damages may not apply to you.

This warranty provides the original purchaser with specific rights. For information regarding those rights, please consult the applicable state laws.



P.O. Box 90004
Bowling Green, KY 42102-9004
www.desatech.com

DESA
Industries of Canada, Inc.

2220 Argentia Road
Unit #4
Mississauga, Ontario
L5N 2K7
905-826-8010
FAX 905-826-8236
www.desatech.com