

PK16488 - XRCV4G35 - AR - Pump

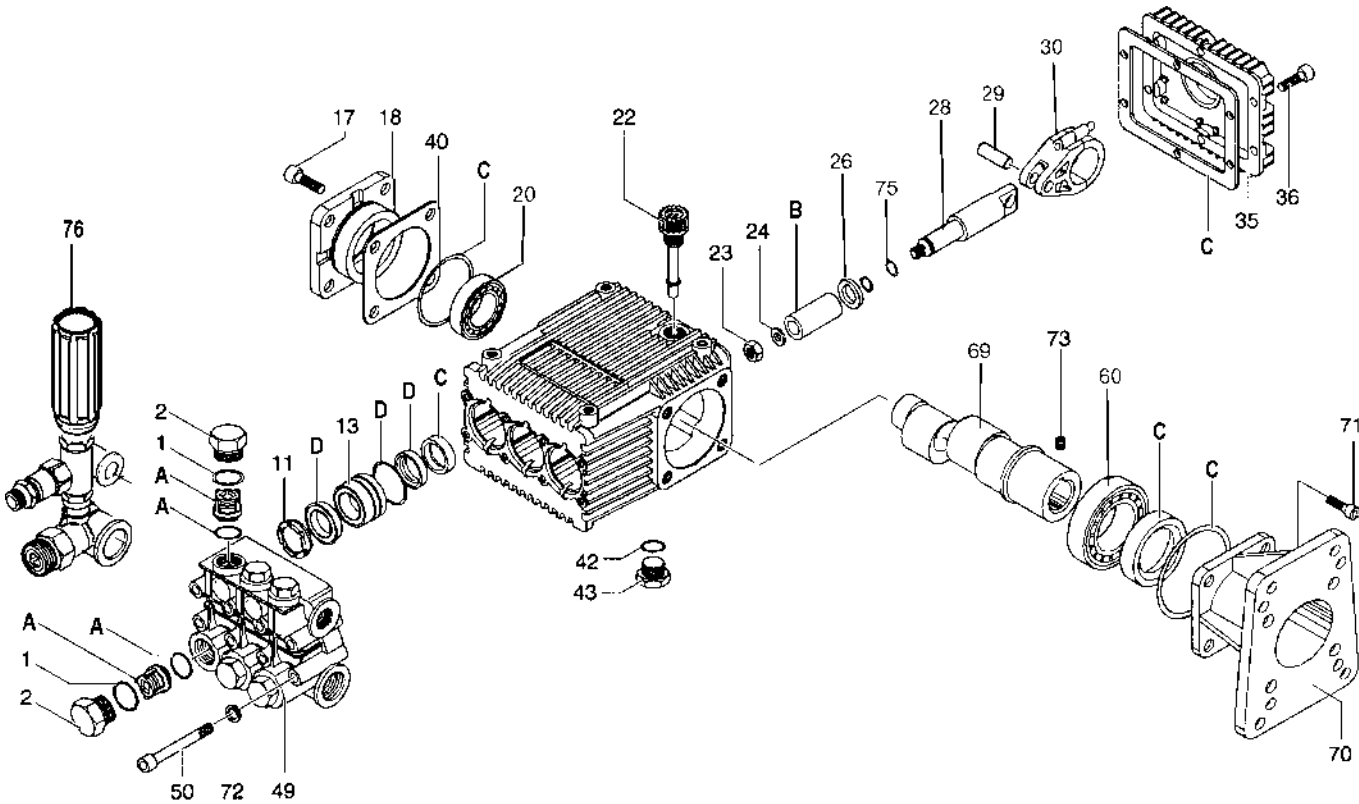

PK16488 - XRCV4G35N - AR PUMP PARTS LIST

<u>Key #</u>	<u>Part #</u>	<u>Description</u>
1	AR-960160	O-ring
2	AR-960850	Plug
11	AR-960110	Support Ring
13	AR-1380090	Piston Guide
17	AR-850370	Screw
18	AR-1380050	Bearing Support
20	AR-840370	Bearing
22	AR-880130	Oil Cap
23	AR-962010	Nut
24	AR-962000	Washer
26	AR-1380950	Spacer
28	AR-1380920	Piston Guide
29	AR-1380060	Piston Pin
30	AR-1380290	Connecting Rod (Bronze)
35	AR-1389010	Complete Cover - One bolt hole on top and bottom — two bolt holes on left and right
	AR-1789010	Complete Cover - One bolt hole on left and right — two bolt holes on top and bottom
36	AR-1381680	Screw
40	AR-1380120	.10 mm Shim
	AR-1380130	.20 mm Shim
	AR-1380530	.25 mm Shim
	AR-1382810	.05 mm Shim
42	AR-740290	O-ring
43	AR-880530	Plug
49	AR-1382850	Pump Head
50	AR-820150	Screw
60	AR-1380320	Bearing
69	AR-1380590	Hollow Shaft 1"
70	AR-1380550	Engine Flange
71	AR-180030	Screw
72	AR-1381850	Washer
73	AR-820440	Grub Screw
75	AR-1080401	Ring
76	AR-20242	Unloader
A	AR-1828	Valve Kit
B	AR-2737	Plunger Kit
C	AR-1856	Oil Seal Kit
D	AR-1857	Water Seal Kit

General Information:

- 30W non-detergent oil, 18.54 oz.
- Fill to the middle of sight glass
- Uses the 15124 chemical injector
- Replacement part for XRCV4G35N: 16488 (XRCV4G35N) pump, 15124 chemical injector, 15913 hose, S065 clamp, H100 chemical hose, 16506 thermal relief valve, 17098 inline filter, 16776 easy start valve, F035 quick connect, M036 key, 15282 screw (qty 4 pump to engine), F107 lock washer screw (qty 4 pump to engine)

PK16488 - XRCV4G35N - AR PUMP - REPAIR KITS

AR-1828 Valve Kit



AR-1856 Gasket Kit



AR-1857 Water Seal Kit



AR-2737 Plunger Kit

