

SPG7085E

GENERATOR OPERATOR'S MANUAL

PLEASE READ THIS MANUAL CAREFULLY BEFORE OPERATION

MANUAL DEL OPERADOR DEL GENERADOR

LEA ESTE MANUAL ATENTAMENTE ANTES DE LA OPERACIÓN

MANUEL D'UTILISATION DU GÉNÉRATEUR

VEUILLEZ LIRE ATTENTIVEMENT CE MANUEL AVANT L'UTILISATION

⚠ DANGER:



DEADLY EXHAUST FUMES! ONLY use OUTSIDE far away from windows, doors and vents!



NOT INTENDED FOR USE IN CRITICAL LIFE SUPPORT APPLICATIONS.



SAVE this Manual. Provide this manual to any operator of the generator.



⚠ WARNING

This product and its exhaust can expose you to chemicals including lead and lead compounds, and carbon monoxide, which are known to the State of California to cause cancer and birth defects or other reproductive harm. For more information go to www.P65Warnings.ca.gov.

This Manual contains important safety information and instructions for operating this generating set. **PLEASE READ THIS MANUAL CAREFULLY.** Failure to do so could result in property damage and/or personal INJURY/DEATH.

Provide this manual to any operator of this generator. This manual should be considered as a permanent part of your generator and should remain with it when you sell it.

The pictures and figures in the manual shall be only for reference. There may be differences between the pictures and figures and the physical product.

Table of contents

Operator Safety.....	2
Safety Rules.....	2
Getting Started.....	5
Know the generator.....	7
Features and Controls.....	9
Operating.....	9
Operating Checklist.....	9
High Altitude.....	9
Operating Condition.....	9
Engine Oil.....	9
Engine Fuel.....	10
Electrical Devices.....	11
Grounding.....	11
Starting the Engine.....	11
Connect to Electrical Devices.....	12
Charging a Battery.....	12
Stopping the Engine.....	13
Maintenance.....	13
Maintenance Schedule.....	14
Generator Maintenance.....	14
Engine Maintenance.....	14
Engine Oil.....	14
Add Oil.....	14
Change Oil.....	15
Air Filter.....	15
Spark Plug.....	15
Spark Arrester.....	15
Idle Speed.....	16
Adjustment.....	16
Trouble Analysis and Troubleshooting.....	16
Storage and Transportation.....	16
Storage.....	16
Transportation.....	16
Specification.....	17
Specification Parameter Table.....	17
Wiring Diagram for 60Hz.....	18
Limited Warranty.....	19

SAVE THESE INSTRUCTIONS FOR FUTURE USE

All information in this publication is based on the latest product information available at the time of printing. We reserve the right to change, alter and/or improve the product and this document at any time without notice and without incurring any obligation.

Write down the serial number and purchase information of the generator. Keep this manual and the receipt for future reference.

Model: _____

Serial number: _____

Date of purchase: _____

OPERATOR SAFETY

Safety Rules



Pay attention to this safety alert symbol. Obey all safety messages that follow this symbol to avoid possible property damage, INJURY or DEATH. Each safety message is preceded by a safety alert symbol and one of three words, DANGER, WARNING, or CAUTION.

⚠ DANGER:

Indicates a hazardous situation that, if not strictly complied with, will result in substantial property damage, serious injury or DEATH.

⚠ WARNING:

Indicates a hazardous situation that, if not strictly complied with, may result in property damage, serious injury or DEATH.

⚠ CAUTION:

Indicates a hazardous situation that, if not strictly complied with, could result in property damage or injury.



⚠ WARNING:

READ THIS MANUAL COMPLETELY BEFORE OPERATING.

DO NOT operate this generator until you have read ALL safety, operation, and maintenance Instructions listed in this manual.

Failure to follow the instructions may result in property damage, INJURY or DEATH.

The warnings and precautions discussed in this manual cannot cover all possible conditions and situations that may occur. It must be understood by the operator that common sense and caution are factors which cannot be built into this product, but must be possessed by the operator.

⚠ WARNING:

This generator is intended for residential consumer use only. DO not modify the engine and do not use the engine for a purpose for which it is not intended.



⚠ WARNING:

KICKBACK

Rapid retraction of the starter cord will pull your hand and arm towards the generator faster than you can let go.

Accidental starts can result in entanglement, traumatic amputation or laceration.

Broken bones, fractures, bruises or sprains could result.

⚠ WARNING:

Before each use, check for loose or damaged parts, signs of oil or fuel leaks, and any other condition that may affect proper operation. Repair or replace all damaged or defective parts immediately.

Locate all operating controls and safety labels.

Keep all safety guards in place and in proper working order at all times.

DO NOT allow any material to block the cooling slots.

DO NOT allow children or untrained persons to operate the generating set.

DO NOT run the generator unattended. Turn off the generator before leaving the area.



⚠ WARNING:

FIRE

Operation of this generator may create sparks that can start fires around dry vegetation.

This generator may not be equipped with a spark arresting muffler. If the generator will be used around flammable materials, or on land covered with materials such as agricultural crops, forest, brush, grass, or other similar items, then an approved spark arrester must be installed.

In some area, a spark arrester is required by law. Please contact local fire agencies for laws or regulations relating to fire prevention requirements.

⚠ WARNING:

Read the instructions provided with the equipment that is powered by this engine for any additional safety rules that should be observed in conjunction with generator startup, shutdown, operation, or protective apparel that may be needed to operate the equipment.



⚠ WARNING:

HOT SURFACE

The running generator produces heat. Severe burns can occur on contact.

DO NOT touch generator while operating or just after stopping. Avoid contact with hot exhaust gases.

Maintain at least three feet of clearance on all sides to ensure adequate cooling.

Combustible material can catch fire on contact. Maintain at least five feet of clearance from combustible materials.



⚠ DANGER:

TOXIC FUMES

The exhaust of the engine contains carbon monoxide, an odorless, colorless, poison gas. Using engine indoors CAN KILL YOU!

NEVER use inside any building or any kind of enclosure, EVEN IF doors and windows are open.

Place the generator in a well ventilated area and carefully consider wind and air currents when positioning the generator.



⚠ DANGER:

FIRE OR EXPLOSION

Gasoline is highly flammable and extremely explosive.

Fire or explosion can cause severe burns or death.

Keep flammable items away while handling gasoline.

Fill fuel tank outdoors and in a well-ventilated area with the generator stopped.

Always wipe off spilled fuel and wait until the fuel has dried before starting the generator.

DO NOT operate the generator with known leaks in the fuel system.

Use proper fuel storage and handling procedures. DO NOT store fuel or other flammable materials nearby.

Empty the fuel tank before storing or transporting this generator.

Keep fire extinguisher handy and be prepared if a fire starts.



⚠ DANGER:

MOVING PARTS

Moving parts can cause severe injury. Keep hands and feet away.

DO NOT operate generator with covers, shrouds, or guards removed.

DO NOT wear loose-fitting clothing, dangling drawstrings or items that could become caught. Tie up long hair and remove jewelry.

NEVER place fingers, hands, or body near the generator when it is running period.

⚠ WARNING:

ACID

(For types equipped with battery)

Be careful when using any battery.

Keep away from open flames, heat or spark.

Battery will exhaust hydrogen while charging. Only charge a battery in a well ventilated place.

Avoid spilled battery acid. If contact with skin is made, wash immediately with clean water.

GENERAL HAZARDS



- NEVER operate in an enclosed area, in a vehicle, or indoors EVEN IF doors and windows are open.
- For safety reasons, the manufacturer recommends that the maintenance of this equipment is carried out by an Authorized Dealer. Inspect the generator regularly, and contact the nearest Authorized Dealer for parts needing repair or replacement.
- Operate generator only on level surfaces and where it will not be exposed to excessive moisture, dirt, dust or corrosive vapors.
- Keep hands, feet, clothing, etc., away from drive belts, fans, and other moving parts. Never remove any fan guard or shield while the unit is operating.
- Certain parts of the generator get extremely hot during operation. Keep clear of the generator until it has cooled to avoid severe burns.
- DO NOT operate generator in the rain.
- DO not alter the construction of the generator or change controls which might create an unsafe operating condition.
- Never start or stop the unit with electrical loads connected to receptacles AND with connected devices turned ON. Start the engine and let it stabilize before connecting electrical loads. Disconnect all electrical loads before shutting down the generator.
- DO NOT insert objects through unit's cooling slots.
- When working on this equipment when physically or mentally fatigued.
- Never use the generator or any of its parts as a step. Stepping on the unit can stress and break parts, and may result in dangerous operating conditions from leaking exhaust gases, fuel leakage, oil leakage, etc.

NOTE:

This generator may be equipped with a spark arrestor muffler. The spark arrestor must be maintained in effective working order by the owner/operator. In the State of California, a spark arrestor is required by law (Section 4442 of the California Public Resources Code). Other states may have similar laws. Federal laws apply on federal lands.

EXHAUST & LOCATION HAZARDS

- NEVER operate in an enclosed area or indoors! NEVER use in the home, in a vehicle, or in partly enclosed areas such as garages, EVEN IF doors and windows are open! ONLY use outdoors and far from open windows, doors, vents, and in an area that will not accumulate deadly exhaust.

 DANGER	
Using a generator indoors CAN KILL YOU IN MINUTES. Generator exhaust contains carbon monoxide. This is a poison you cannot see or smell.	
 NEVER use inside a home or garage, EVEN IF doors and windows are open.	 Only use OUTSIDE and far away from windows, doors, and vents.

- The engine exhaust fumes contain carbon monoxide, which you cannot see or smell. This poisonous gas, if breathed in sufficient concentrations, can cause unconsciousness or even death.
- Adequate, unobstructed flow of cooling and ventilating air is critical to correct generator operation. Do not alter the installation or permit even partial blockage of ventilation provisions, as this can seriously affect safe operation of the generator. The generator MUST be operated outdoors.

- This exhaust system must be properly maintained. Do nothing that might render the exhaust system unsafe or in noncompliance with any local codes and/or standards.
- Always use a battery operated carbon monoxide alarm indoors, installed according to the manufacturer's instructions.
- If you start to feel sick, dizzy, or weak after the generator has been running, move to fresh air IMMEDIATELY. See a doctor, as you could have carbon monoxide poisoning.

ELECTRICAL HAZARDS

- The generator produces dangerously high voltage when in operation. Avoid contact with bare wires, terminals, connections, etc., while the unit is running, even on equipment connected to the generator. Ensure all appropriate covers, guards and barriers are in place before operating the generator.
- Never handle any kind of electrical cord or device while standing in water, while barefoot or while hands or feet are wet. **DANGEROUS ELECTRICAL SHOCK MAY RESULT.**
- The National Electric Code (NEC) requires the frame and external electrically conductive parts of the generator be properly connected to an approved earth ground. Local electrical codes may also require proper grounding of the generator. Consult with a local electrician for grounding requirements in the area.
- Use a ground fault circuit interrupter in any damp or highly conductive area (such as metal decking or steel work).
- Do not use worn, bare, frayed or otherwise damaged electrical cord set with the generator.
- Before performing any maintenance on the generator, disconnect the engine starting battery (if equipped) to prevent accidental start up. Disconnect the cable from the battery post indicated by a NEGATIVE, NEG or (-) first. Reconnect that cable last.
- In case of accident caused by electric shock, immediately shut down the source of electrical power. If this is not possible, attempt to free the victim from the live conductor. **AVOID DIRECT CONTACT WITH THE VICTIM.** Use a non-conducting implement, such as a rope or board, to free the victim from the live conductor. If the victim is unconscious, apply first aid and get immediate medical help.

FIRE HAZARDS

- Gasoline is highly **FLAMMABLE** and its vapors are **EXPLOSIVE**. Never permit smoking, open flames, sparks or heat in the vicinity while handling gasoline.
- Never add fuel while unit is running or hot. Allow engine to cool completely before adding fuel.
- **Never fill fuel tank indoors.** Comply with all laws regulating storage and handling of gasoline.
- **Do not overfill the fuel tank. Always allow room for fuel expansion.** If tank is over-filled, fuel can overflow onto a hot engine and cause FIRE or an EXPLOSION. Never store generator with fuel in tank where gasoline vapors might reach an open flame, spark or pilot light (as on a furnace, water heater or clothes dryer). FIRE or EXPLOSION may result. Allow unit to cool entirely before storage.
- Wipe up any fuel or oil spills immediately. Ensure that no combustible materials are left on or near the generator. Keep the area surrounding the generator clean and free from debris and keep a clearance of five (5) feet on all side to allow for proper ventilation of the generator.
- Do not insert objects through unit's cooling slots.
- **Never** operate the generator if connected electrical devices overheat, if electrical output is lost, if engine or generator sparks or if flames or smoke are observed while unit is running.
- Keep a fire extinguisher near the generator at all times.

STANDARDS INDEX

1. National Fire Protection Association (NFPA) 70: The NATIONAL ELECTRIC CODE (NEC) available from www.nfpa.org
2. National Fire Protection Association (NFPA) 5000: BUILDING CONSTRUCTION AND SAFETY CODE available from www.nfpa.org
3. International Building Code available from www.iccsafe.org
4. Agricultural Wiring Handbook available from www.nerc.org , Rural Electricity Resource Council P.O. Box 309 Wilmington, OH 45177-0309
5. ASAE EP-364.2 Installation and Maintenance of Farm Standby Electric Power available from www.asabe.org, American Society of Agricultural & Biological Engineers 2950 Niles Road, St. Joseph, MI 49085

This list is not all inclusive. Check with the Authority Having Local Jurisdiction (AHJ) for any local codes or standards which may be applicable to your jurisdiction.

MODEL NO:	
SERIAL NO:	

Unit ID location

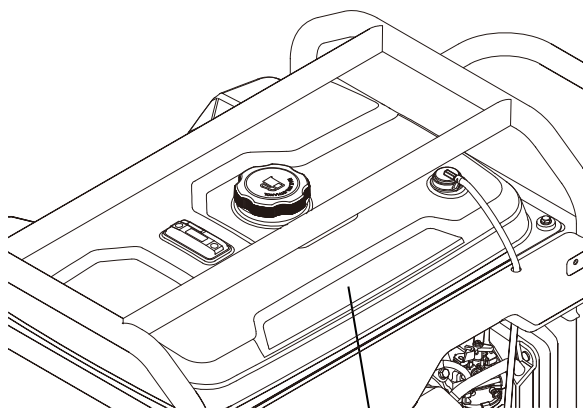

MODEL DATA DECAL

GETTING STARTED

Unpacking

Remove the generator from the shipping carton

- Place the shipping carton on a solid, flat surface.
- Carefully cut each corner of the carton box from top to bottom. Fold each side flat on the ground.
- Remove everything from the carton except the generator.

Assembly

Your generator requires some assembly. If you have any questions regarding the assembly of your generator, please have your model number and serial number ready and consult FNA Group at cservice@fna-group.com or 1-877-362-4271.

Install Wheel Kit

Put axle through wheel and mounting lug hole, then fix with the clip.

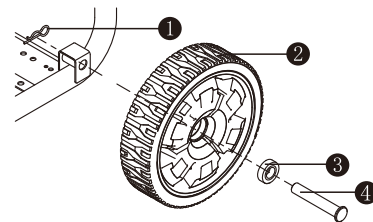

- ① Clip
- ② Wheel
- ③ Washer
- ④ Axle

NOTE:

The wheels are not intended for over-the-load use.

Install Support Bracket

Use supporting bracket bolt to pass through the supporting bracket and the mounting hole on the frame, attach the nut and tighten until snug.

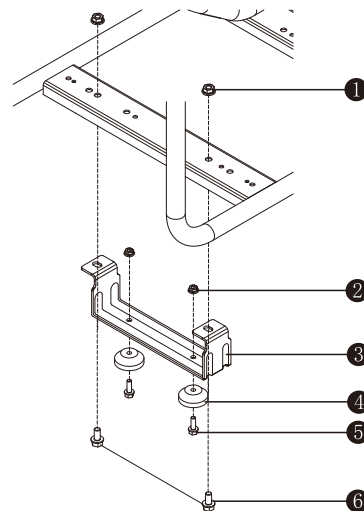

- ① Supporting bracket nut M8
- ② Damping seat nut M6
- ③ Support bracket
- ④ Damping foot
- ⑤ Damping foot bolt M6 x18
- ⑥ Supporting bracket bolt M8 x 16

Battery cable connection

Battery not included. Reference engine manual for battery specifications and installation instructions

Emission Information

The Environmental Protection Agency (and California Air Resource Board for generators certified to CA standards) requires that this generator comply with exhaust and evaporative emission standards. Locate the emissions compliance decal on the engine to determine what standards the generator meets, and to determine which warranty applies. This generator is certified to operate on gasoline. The emission control system includes the following components (if equipped):

- Air Induction System
 - Intake Pipe / Manifold
 - Air Cleaner
- Fuel System
 - Carburetor
 - Fuel Tank / Cap
 - Fuel Lines
 - Evaporative Vent Lines
 - Carbon Canister
- Ignition System
 - Spark Plug
 - Ignition Module
- Exhaust System
 - Exhaust Manifold
 - Muffler
 - Pulsed Air Valve
 - Catalyst

KNOW THE GENERATOR

- 1. 120 Volt AC, 20 Amp, Duplex Receptacle (L5-20R)** – Supplies electrical power for the operation of 120 Volt AC, 20 Amp, single-phase, 60 Hz electrical lighting, appliance, tool and motor loads.
- 2. 120 Volt AC, 30 Amp Receptacle (L5-30R)** – Supplies electrical power for the operation of 120 Volt AC, 30 Amp, single-phase, 60 Hz electrical lighting, appliance, tool and motor loads.
- 3. Ground terminal** – Used to connect the generator to the ground.
- 4. 120/240 Volt AC, 30 Amp Receptacle (L14-30R)** – Supplies electrical power for the operation of 120 and/or 240 Volt AC, 30 Amp, single-phase, 60 Hz, electrical lighting, appliance, tool and motor loads.
- 5. Hourmeter** – Tracks hours of operation.
- 6. Circuit Breakers (AC)** – Protect the generator and receptacle against electrical overload.
- 7. Start Switch** – Used to start engine from the starter motor (electric start models only).
- 8. Main Breakers** – Protect the generator against power overload.

Control panel:

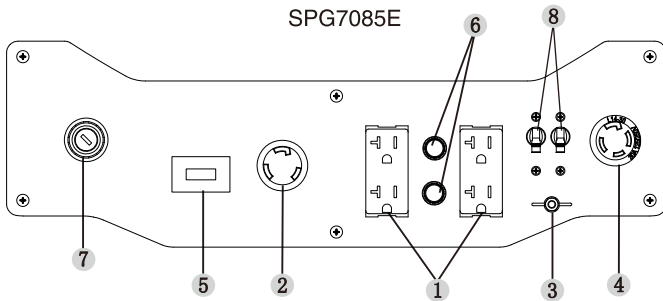

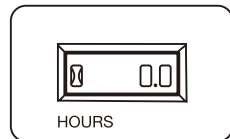

Hour meter





Display:

The hour meter tracks hours of operation for scheduled maintenance.

- a. Run Time Counter, hour glass icon will flash while generator is running: 

- b. Total running time: 

- c. Check oil:  

- d. Maintenance:  

Check oil: This message will actually begin flashing at 99 hours and disable itself at 102 hours, providing a three hour window to perform the service.

Maintenance: After 100 hours cumulative running time, every 100 hours the "SVC" icon on the lower right hand corner of the display will flash. The message will flash one hour before and two hours after each 100 hours interval providing a three hour window to perform service.

Note:

The hour glass graphic will flash on and off when the engine is running. This signifies that the meter is tracking hours of operation.

⚠ DANGER:



Never operate in an enclosed area or indoors! NEVER use in the home, in a vehicle, or in partly enclosed areas such as garages, EVEN IF doors and windows are open! ONLY use outdoors and far from open windows, doors, vents, and in an area that will not accumulate deadly exhaust.



The engine exhaust fumes contain carbon monoxide, which you cannot see or smell. This poisonous gas, if breathed in sufficient concentrations, can cause unconsciousness or even death.



Adequate, unobstructed flow of cooling and ventilating air is critical to correct generator operation. Do not alter the installation or permit even partial blockage of ventilation provisions, as this can seriously affect safe operation of the generator. The generator MUST be operated outdoors.



This exhaust system must be properly maintained. Do nothing that might render the exhaust system unsafe or in noncompliance with any local codes and/or standards.



Always use a battery operated carbon monoxide alarm indoors, installed according to the manufacturer's instructions.

⚠ DANGER

Using a generator indoors CAN KILL YOU IN MINUTES.
Generator exhaust contains carbon monoxide. This is a poison you cannot see or smell.



NEVER use inside a home or garage, EVEN IF doors and windows are open.

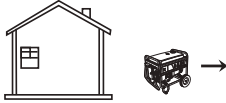

Only use OUTSIDE and far away from windows, doors, and vents.

Grounding the generator when used as a portable

This generator has an equipment ground that connects the generator frame components to the ground terminals on the AC output receptacles (see NEC 250.34 (A) for explanation). This allows the generator to be used as a portable without grounding the frame of the generator as specified in NEC 250.34.

Special Requirements

There may be Federal or State Occupational Safety and Health Administration (OSHA) regulations, local codes, or ordinances that apply to the intended use of the generator.

Please consult a qualified electrician, electrical inspector, or the local agency having jurisdiction:

- In some areas, generators are required to be registered with local utility companies.
- If the generator is used at a construction site, there may be additional regulations which must be observed.

Connecting the generator to a building's electrical system

When connecting directly to a building's electrical system, it is recommended that a manual transfer switch is used. Connections for a portable generator to a building's electrical system must be made by a qualified electrician and in strict compliance with all national and local electrical codes and laws.

WATTAGE REFERENCE GUIDE

Device	Running Watts
*Air Conditioner (12,000 Btu)	1700
*Air Conditioner (24,000 Btu)	3800
*Air Conditioner (40,000 Btu)	6000
Battery Charger (20 Amp)	500
Belt Sander (3")	1000
Chain Saw	1200
Circular Saw (6-1/2")	800 to 1000
*Clothes Dryer (Electric)	5750
*Clothes Dryer (Gas)	700
*Clothes Washer	1150
Coffee Maker	1750
*Compressor (1 HP)	2000
*Compressor (3/4 HP)	1800
*Compressor (1/2 HP)	1400
Curling Iron	700
*Dehumidifier	650
Disc Sander (9")	1200
Edge Trimmer	500
Electric Blanket	400
Electric Nail Gun	1200
Electric Range (per element)	1500
Electric Skillet	1250
*Freezer	700
*Furnace Fan (3/5 HP)	875
*Garage Door Opener	500 to 750
Hair Dryer	1200
Hand Drill	250 to 1100
Hedge Trimmer	450
Impact Wrench	500
Iron	1200
*Jet Pump	800
Lawn Mower	1200
Light Bulb	100
Microwave Oven	700 to 1000
*Milk Cooler	1100
Oil Burner on Furnace	300
Oil Fired Space Heater (140,000 Btu)	400
Oil Fired Space Heater (85,000 Btu)	225
Oil Fired Space Heater (30,000 Btu)	150
*Paint Sprayer, Airless (1/3 HP)	600
Paint Sprayer, Airless (handheld)	150
Radio	50 to 200
*Refrigerator	700
Slow Cooker	200
*Submersible Pump (1-1/2 HP)	2800
*Submersible Pump (1 HP)	2000
*Submersible Pump (1/2 HP)	1500
*Sump Pump	800 to 1050
*Table Saw (10")	1750 to 2000
Television	200 to 500
Toaster	1000 to 1650
Weed Trimmer	500

* Allow 3 times the listed watts for starting these devices.

FEATURES AND CONTROLS

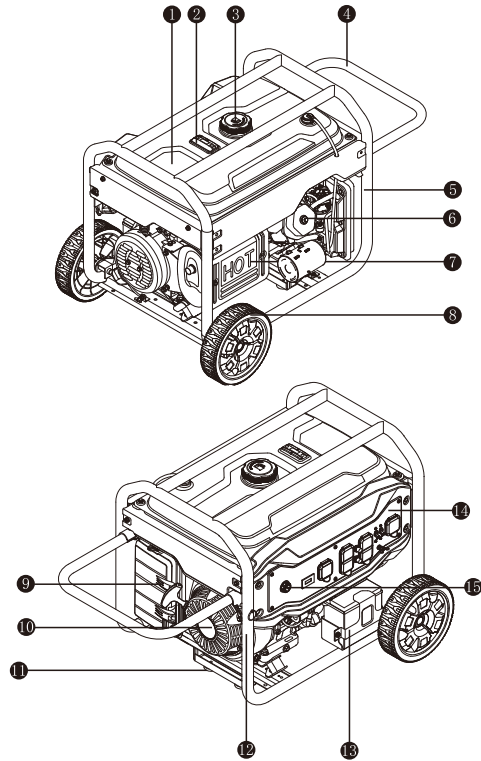

- | | |
|-------------------|--------------------|
| 1 Fuel tank | 9 Air filter |
| 2 Level indicator | 10 Recoil Starter |
| 3 Fuel tank cap | 11 Support bracket |
| 4 Handle | 12 Handle stop pin |
| 5 Frame | 13 Battery |
| 6 Cylinder head | 14 Control panel |
| 7 Muffler guard | 15 Engine switch |
| 8 Wheel | |

OPERATING

Operating Checklist

Operating Location

- Only use OUTSIDE and place the generator in a well-ventilated area and carefully consider wind and air currents.
- Place the generating set on a level surface before any operation.
- Allow two feet clearance on all sides of the generator while operating.



⚠ DANGER:

TOXIC FUMES

The exhaust of the generator contains carbon monoxide, an odorless, colorless, poison gas. Using the generator indoors CAN KILL YOU!

NEVER use inside any building or any kind of enclosure, EVEN IF doors and windows are open.

Place the generator in a well-ventilated area and carefully consider wind and air currents when positioning generator.

High Altitude

This engine will have proper engine performance and emission control when it is operated at or below an altitude of 5000 feet (1524 meters). This engine requires a high altitude carburetor kit to ensure proper engine performance and emission control when it is operated at altitudes above 5000 feet (1524 meters). Operating the engine with the wrong engine configuration above 5000 feet (1524 meters) may increase its emissions and decrease fuel efficiency and performance. To obtain a high altitude carburetor kit, contact FNA Group at cservice@fna-group.com or 1-877-362-4271.

⚠ CAUTION:

Operation of the engine with a high altitude carburetor kit at an altitude below 5000 feet (1524 meters) may cause the engine to overheat and result in serious engine damage.

Operating Condition

- Check for loose or damaged parts, signs of oil or fuel leaks, and any other condition that may affect proper operation.
- Repair or replace all damaged or defective parts immediately.

⚠ WARNING:

Failing to correct problem(s) before operation could result in property damage, serious injury or DEATH.

- Remove any excessive dirt or debris, especially around the muffler and recoil starter.
- DO NOT move or tip the generator during operation.
- Use generator only for intended uses. If you have questions about intended use, please feel free to ask FNA Group at cservice@fna-group.com or 1-877-362-4271.

Engine oil

- Place the generator on a level surface with it stopped.
- Remove the dipstick and wipe it clean.

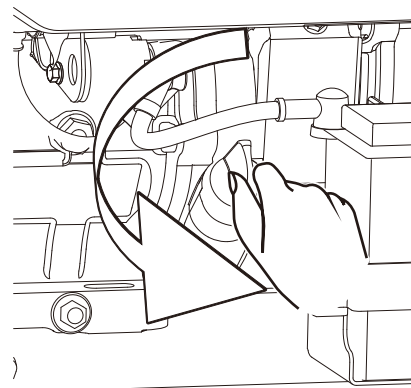

Remove dipstick

- Reinstall dipstick into tube; rest on oil fill neck, DO NOT thread cap into tube.
- Remove the dipstick again and check oil level. Level should be at top of indicator on dipstick.

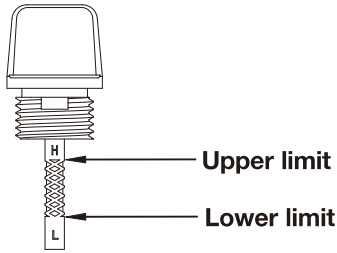

Oil level gauge

- Fill to the upper limit of the dipstick with the recommended oil if the oil level is low.
- Reinstall and fully tighten the dipstick.
- Engine damage could result from insufficient lubrication. Refer to **add oil** instruction in **MAINTENANCE** section for more information.
- See **SPECIFICATIONS** for oil capacity (rated).

⚠ WARNING:

This engine is not filled with oil at the factory. Any attempt to crank or start the engine before it has been properly filled with the recommended type and amount of oil may result in engine damage and void your warranty.

⚠ WARNING:

Oil is a major factor affecting performance and service life. Use 4-stroke automotive detergent oil recommended in the **MAINTENANCE** section of this manual.

⚠ WARNING:

Operate generator only on level surfaces. The low oil sensor (if equipped) will automatically stop the engine when the oil level falls below the safe limit. To avoid the inconvenient of an unexpected shutdown, fill to the upper limit and check the oil level regularly.

Engine fuel

- With the engine stopped, check the fuel level gauge. Refill the fuel tank if necessary.

⚠ CAUTION:

Pressure can build up in the fuel tank. Allow the engine to cool for at least two minutes before removing fuel cap. Loosen the fuel cap slowly to relieve any pressure in the tank.

- Use clean, fresh regular unleaded gasoline with a minimum octane rating of 87. DO NOT mix oil with gasoline or use gasoline older than 30 days. DO NOT use gasoline that contains more than 10% ethyl alcohol. E15, E20 and E85 are NOT approved fuels and should NOT be used.
- Be sure not to fill the fuel tank above the upper limit mark. Always allow room for fuel expansion.
- See **SPECIFICATIONS** for fuel capacity (rated).

LOOK BEFORE YOU PUMP!

Ethanol Percentage

<10% OK NO 15% - 30% - 85%

DO NOT USE FUEL CONTAINING GREATER THAN 10% ETHANOL!
N'UTILISEZ PAS UN CARBURANT DONT LA TENEUR EN ETHANOL EST SUPERIEURE A 10%!
¡NO UTILICE COMBUSTIBLES QUE CONTENGAN MAS DE 10% DE ETANOL!

IMPORTANT: Ethanol Shield™ (sold separately) is a fuel stabilizer that helps eliminate and prevent ethanol related problems in power equipment. Follow the instructions on the container and add to the gasoline.

Ethanol Percentage

<10% OK NO 15% - 30% - 85%

NOTICE: Use of fuels with greater than 10% ethanol are not approved for use in this product per EPA regulations and will damage the unit and void the warranty.

MAXIMUM fuel adding position

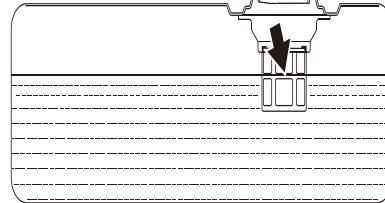

⚠ WARNING:

Do not fill the fuel tank above the maximum fuel level. Over fill will result in engine die or damage the carbon canister (if equipped) and void your warranty.



⚠ DANGER:

FIRE OR EXPLOSION

Gasoline is highly flammable and extremely explosive. Fire or explosion can cause severe burns or death. Keep flammable items away while handling gasoline. Fill fuel tank outdoors and in a well-ventilated area with the engine stopped. Always wipe off spilled fuel and wait until the fuel has dried before starting the engine. DO NOT operate the engine with known leaks in the fuel system. Use proper fuel storage and handling procedures. DO NOT store fuel or other flammable materials nearby. Empty the fuel tank before storing or transporting this engine. Keep fire extinguisher handy and be prepared if a fire starts.

NEVER use engine or carburetor cleaner products in the fuel tank or permanent damage may occur.

It is important to prevent gum deposits from forming in essential fuel system parts, such as the carburetor, fuel filter, fuel hose or tank during storage. Also, experience indicates that alcohol-blended fuels (called gasohol, ethanol or methanol) can attract moisture, which leads to separation and formation of acids during storage.

Acidic fuel can damage the fuel system of an engine while in storage. Be sure to review the instructions given in "Storage" section.

Gasoline/Alcohol Blends: up to 10% alcohol, 90% unleaded gasoline by volume is approved as a fuel. Other gasoline/alcohol blends are not approved. Effects of old, stale or contaminated fuel are not warrantable.

⚠ CAUTION:

To minimize gum deposits in your fuel system and to insure easy starting, do not use gasoline left over from the previous season.

⚠ CAUTION:

Pressure can build up in the fuel tank. Allow the generator to cool for at least two minutes before removing fuel cap. Loosen the fuel cap slowly to relieve any pressure in the tank.

Electrical devices

- Disconnect all electrical devices from the generator and switch off the circuit breaker before start the engine.
- The generator may be hard to start with electrical devices.

Grounding

- The generator must be properly connected to an appropriate ground. It helps prevent electrical shock if a ground fault condition exists in the generator or in connected electrical devices, especially with a wheel kit. Proper grounding also helps dissipate static electricity, which often builds up in ungrounded devices.

⚠ DANGER:

Electric Shock

Failure to properly ground the generator can result in electric shock.

- A ground terminal on the frame of the generator has been provided on the generator end. For remote grounding, connect of a length of heavy gauge (4mm²) copper wire between the generator ground terminal and a copper rod driven into the ground.
- The National Electrical Code requires that the frame and external electrically conductive parts of this generator be properly connected to an approved earth ground. Local electrical codes may also require proper grounding of the unit. We strongly recommend that you consult with a qualified electrician for grounding requirements in your area.

Starting the engine

1. Perform **OPERATING CHECKLIST** (Page 9).
2. Turn fuel valve to the **"ON"** position.



3. Turn off AC breaker protector. (If it is not equipped with AC breaker protector, please remove all loads or electrical devices)
4. Pull the choke valve switch to **"CLOSE"** position.

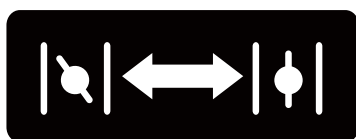

CLOSE

OPEN

⚠ CAUTION:

Choke position for starting may vary depending upon temperature and other factors. If re-starting a warm engine, the choke should be left in the **HALF** or **CLOSE** position.

5. **Electric start:** Turn and keep the key to "START" position till the engine is started. After the engine is started, release the key to return to **"ON"** position.

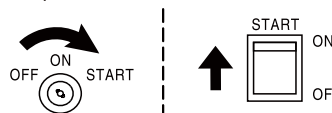

Electric start

- Manual start:** Turn the switch to "ON" position and then seize the starter handle and slowly pull until there is a sense of resistance felt, and quickly pull to start.

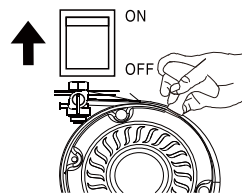

Manual start

⚠ WARNING:

KICKBACK

Rapid retraction of the starter cord will pull your hand and arm towards the engine faster than you can let go. Accidental starts can result in entanglement, traumatic amputation or laceration. Broken bones, fractures, bruises or sprains could result.

- If the starter fails to start the engine, immediately turn off the starter. Don't attempt to restart the engine before the failure cause is identified. Don't restart the engine by replacement of other storage battery without authorization.

⚠ CAUTION:

If the engine fails to start after attempt for 3 times or flames out after starting, inspect and ensure that the generator is placed in horizontal surface and enough engine oil is included.

During starting, don't keep the starting switch to "start" position for more than 5 seconds, otherwise it is possible to damage the starter motor. If the unit fails to start within first time, restart after about 10 seconds. After the unit is used for a period, if the starting speed of the motor falls, please replace the storage battery.

During the operation of the unit, the storage battery supplies power for the solenoid valve of the carburetor. For this, when the unit is turned off, make sure that the starting switch is in **"OFF"** position and otherwise the storage battery voltage is reduced due to the operating solenoid valve of the carburetor, impacting on starting for next time.

If the engine is equipped with an engine oil alarm, it is possible to prevent engine start when the engine oil in the crankcase is lower than minimum level.

During running-in, routinely inspect the engine oil. See Maintenance section for recommended maintenance period.

6. After the engine is running, move the choke valve to “OPEN” position.

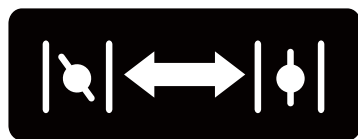

CLOSE

OPEN

⚠ WARNING:

Connect the output terminal of the generating set with the electrical equipment. Don't start or stop the engine when the electrical equipment is in “ON” status.

Connect to electrical devices

Inspect power cord for damage before using. There is a hazard of electric shock from crushing, cutting or heat damage.



⚠ DANGER:

Electric Shock

To reduce the risk of electrical shock, DO NOT use electrical cords that are worn, frayed, bare or otherwise damaged. DO NOT touch bare wires of receptacles.

DO NOT handle generating set or electrical cords while standing in water, while barefoot, while hand or feet are wet.

- Allow the engine to stabilize and warm up for a few minutes after starting.
- Make sure the electrical devices in “OFF” position and the load current is not higher than the maximum capacity current of single socket.

⚠ CAUTION:

If the current of single load is higher than the maximum capacity current of single socket, please disconnect the load.

⚠ CAUTION:

If connected devices overheat, turn them off and disconnect them from generator.

Bearing capacity

⚠ WARNING:

DO NOT overload the generating set.

Exceeding the capacity of generator can damage the generator and/or electrical devices connected to it.

- You must make sure your generator can supply enough rated (running) and surge (starting) watts for the electrical devices you will power at the same time. Follow these simple steps to calculate the running and starting watts necessary for your purposes.
 1. Select the electrical devices you will power at the same time.
 2. The amount of power you need to run all the devices is the total rated (running) watts of these items.
 3. Identify how many surge (starting) watts you will need. Surge wattage is the short burst of power needed to start electric motor-driven tools or appliances such as a circular saw or refrigerator.
- Because not all motors start at the same time, total surge watts can be estimated by adding only the electrical device(s) with the highest additional surge watts to the total rated watts from step 2.

⚠ WARNING:

You must isolate the generator from electric utility by opening the electrical system's main circuit breaker or main switch if the generator is used for backup power. Failure to isolate the generator from the power utility may result in injury or death to electric utility workers and damage to the generator due to backfeed of electrical energy.

⚠ WARNING:

Storage batteries give off explosive hydrogen gas while recharging. An explosive mixture will remain around the battery for a long time after it has been charged. The slightest spark can ignite the hydrogen and cause an explosion, resulting in blindness or other serious injury.

⚠ WARNING:

DO NOT allow smoking, open flame, sparks or any other source of heat around a battery. Wear protective goggles, rubber apron and rubber gloves when working around a battery. Battery electrolyte fluid is an extremely caustic sulfuric acid solution that can cause severe burns. If spill occurs flush area with clear water immediately.

⚠ CAUTION:

Use an automotive hydrometer to test battery state of recharge and condition. Follow the hydrometer manufacturer's instructions carefully. Generally, a battery is considered to be at 100% state of charge when specific gravity of its fluid (as measured by hydrometer) is 1.260 or higher.

Stopping the engine

1. Remove all loads on generator.
2. Remove the plug of all electric equipment from the generator panel.

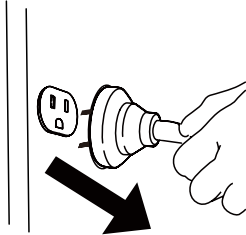

⚠ WARNING:

NEVER stop the engine with electrical devices connected and with the connected devices turned "ON".

3. Allow the generator run at no load for a few minutes to stabilize internal temperatures of the engine and generator.
4. Turn the key to "OFF" position.

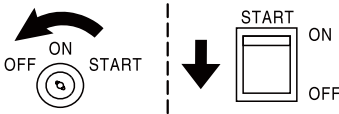

5. Turn the fuel valve to "OFF" position.



MAINTENANCE

A repair shop or person of the owner's choosing may maintain, replace or repair emission control devices and systems; however, warranty replacements or repairs must be performed by an FNA distribution or service center. To obtain information about how to make a warranty claim or to make arrangements for authorized repairs, please contact FNA Group at cservice@fna-group.com or 1-877-362-4271.

It is the owner's/operator's responsibility to complete all scheduled maintenance in a timely manner. Correct any issue before operating the engine. Always follow the inspection and maintenance recommendations and schedules in this manual.

Before servicing the generator, **stop the generator**, disconnect all electrical devices and battery(if equipped) and allow the generator to cool down.

⚠ WARNING:

Improper maintenance or failure to correct a problem before operation can cause a malfunction and result in property damage, serious injury or DEATH. Improper maintenance may void your warranty.



⚠ DANGER:

Accidental starts can cause severe injury or death. Remove and ground spark plug wire before performing any service.

⚠ CAUTION:

The filter element may contain polyaromatic hydrocarbons (PAHs). PAHs are harmful to your health. Please wear gloves for protection during air filter maintenance.

Maintenance Schedule

Follow the service intervals indicated in the chart below. Your generating set may need to be serviced more frequently when operating in adverse conditions, such as excessive dust or airborne debris, high moisture, high vibrations, or intense heat or sunlight.

		Each time before use	The first month or 10 hours ^{Note 2}	Every three months or 50 hours ^{Note 2}	Every six months or 100 hours ^{Note 2}	Every year or 300 hours ^{Note 2}
Engine oil	Inspection	√				
	Replacement		√	√		
Air cleaner	Inspection	√				
	Cleaning			√ ^{Note 3}		
Spark plug	Inspection and adjustment				√	
	Replacement					√
Spark extinguisher ^{Note 1}	Cleaning				√	
Idle speed	Inspection and adjustment					√ ^{Note 4}
Valve clearance	Inspection and adjustment					√ ^{Note 5}
Carbon canister ^{Note 1}	Inspection	Every two years ^{Note 4}				
Low permeability oil tube ^{Note 1}	Inspection	Every two years ^{Note 4}				
Oil tube	Inspection	Every two years ^{Note 4}				

Note 1: Applicable types.

Note 2: Before each season and after then (whichever comes first).

Note 3: Service more frequently under severe, dusty, dirty conditions.

Note 4: To be performed by knowledgeable, experienced owners or the authorized dealer.

Note 5: To be performed by knowledgeable, experienced owners or the authorized dealer, but not necessary to keep the emission control warranty valid.

Generator maintenance

- Make certain that the generator is kept clean and stored properly.
- Use a damp cloth to clean exterior surfaces of the generator.
- Use an air compressor (25 PSI) to clear dirt and debris from the generator.
- Inspect all air vents and cooling slots to ensure that they are clean and unobstructed.

⚠ WARNING:

DO NOT use water to clean the generator. Water can enter the generator through the cooling slots and damage the generator windings.

⚠ WARNING:

DO NOT modify the generator in any way.
DO NOT tamper with governed speed. Generating set supplies correct rated frequency and voltage when running at factory.
 Tampering with the factory set governor will void your warranty.

Engine maintenance

Engine Oil

SAE 10W-30 is recommended for general, all-temperature use. Other viscosities shown in the chart may be used when the average temperature in your area is within the indicated range.

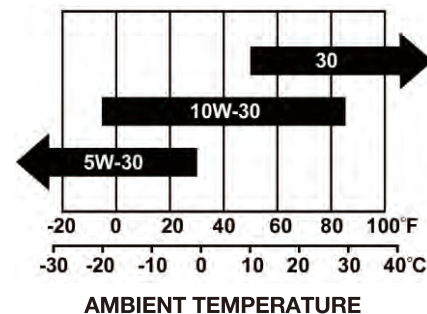

See **SPECIFICATIONS** for oil capacity (rated)

Add Oil

1. Place the engine on a level surface.
2. Remove the dipstick and wipe it clean.

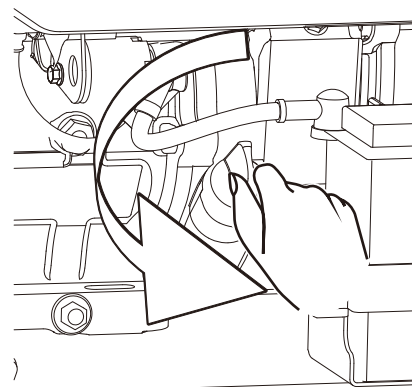

Remove dipstick

3. Add recommended oil to the upper limit.

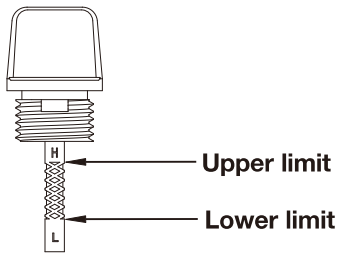

Oil level gauge

4. Fully tighten the dipstick.
5. Properly dispose of any used oil at an approved waste management facility.

Change Oil

CAUTION:

Change oil when the engine is warm from operation.

1. Place the engine on a level surface.
2. Clean area around dipstick and drain plug.
3. Remove oil dipstick.
4. Remove the oil drain plug and allow the oil to drain completely.
5. Reinstall and fully tighten the drain plug.
6. Add recommended oil to the upper limit (see add **OIL** instruction above). Reinstall and fully tighten the dipstick.
7. Dispose of used oil at an approved waste management facility.

WARNING:

The engine is not filled with oil at the factory. Any operation before it has been properly filled with the recommended type and amount of oil may result in engine damage and void your warranty.

Air Filter

1. Loosen the filter fix clamp and remove the cover of the air filter.

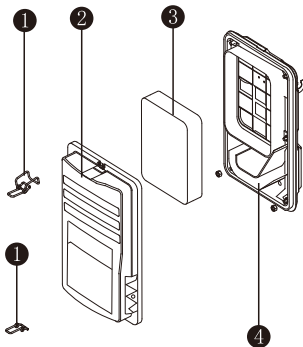

- | | |
|-----------------------|--------------------|
| ① Filter fix clamp | ② Air filter cover |
| ③ Foam filter element | ④ Air filter body |

2. Remove the foam filter element.
3. Wash in liquid detergent and warm water.
4. Squeeze thoroughly dry in a clean cloth.
5. Saturate in clean engine oil.
6. Squeeze in a clean, absorbent cloth to remove all excess oil.
7. Place the filter in the assembly.
8. Fasten the air filter cover with the fix clamp, and then mounting it back to the air filter body.

WARNING:

DO NOT run the engine without the air filter. Serious damage to the engine can result without the air filter.

Spark Plug

1. Clean any dirt from the spark plug cap and spark plug base.
2. Remove the spark plug cap.
3. Use a socket wrench to loosen and remove the spark plug.
4. Inspect the spark plug and spark plug washer. If they are damaged or worn, replace with new one. Clean the spark plug with a wire brush if it can be reused.
5. Check spark plug gap. Carefully bend side electrode to adjust the gap if necessary. **Spark plug gap: 0.6mm - 0.8mm**

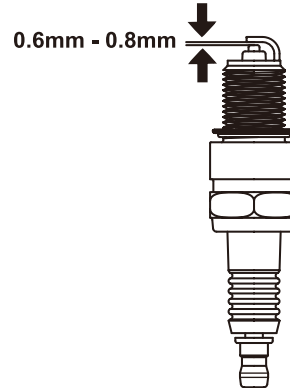

Check spark plug gap

6. Carefully thread the plug into the engine by hand.
7. After the spark plug is seated, use spark plug wrench to tighten the plug. **Spark Plug Torque: 9-12 N.m**
8. Attach the spark plug cap to the plug.

WARNING:

Only use recommended spark plug or equivalent. DO NOT use spark plugs that have improper heat range.

Spark Arrester

(Applicable types)

1. Allow the engine to cool completely before servicing the spark arrester.
2. Remove the two screws holding the cover plate which retains the end of the spark arrester to the muffler.
3. Remove the spark arrester screen.
4. Carefully remove the carbon deposits from the spark arrester screen with a wire brush.
5. Replace the spark arrester if it is damaged.
6. Reinstall the spark arrester in the muffler and attach with the two screws.

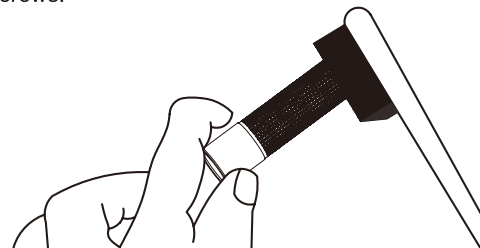

Clean carbon deposits

Idle Speed

The idle speed has been pre-set at the factory and should rarely require readjustment.

WARNING:

Improper adjustment of idle speed will damage your engine and void your warranty

Adjustment

Except as described in this Manual, there is no additional maintenance or adjustment required for your engine.

Improper adjustments or tampering can damage your engine and your equipment and will void your warranty.

WARNING:

Tampering with the factory set governor will damage your engine and void your warranty.

TROUBLE ANALYSIS AND TROUBLESHOOTING

Symptom	Possible Cause	Solutions
Engine cannot be started.	Generating set switch is "OFF".	Turn the switch to the "ON" position.
	There is no fuel.	Fill tank per instructions in this manual.
	Inadequate engine oil.	Check oil level. This engine is equipped with a low oil sensor. The engine cannot be started unless the oil level is above the prescribed lower limit.
	There's no ignition.	Remove the spark plug cap. Clean any dirt from around the plug base, and then remove the spark plug. Install the spark plug in the plug cap. Turn the engine switch "ON". Grounding the electrode to any engine ground, pull the recoil starter to see if sparks jump across the gap. If there is no spark, replace the plug. Reinstall the plug and start engine according to instructions in this manual. Consult Customer Service if necessary.
Generator has no output.	There's no ignition.	Reset circuit breakers.
	Inadequate cord set or extension cords.	Check cord set or extension cords capabilities in section Controls; Cable Size in this manual. Consult Customer Service if necessary.

STORAGE AND TRANSPORTATION

Storage

The generator should be started at least once every two weeks and allowed to run for at least 20 minutes. Follow the instructions below for longer term storage if the generating set will be out of service for 2 months or more.



DANGER:

FIRE OR EXPLOSION

Gasoline is highly flammable and extremely explosive. Empty the fuel tank before storing or transporting the generator.

1. Allow the generator to cool completely before storage.
2. Clean the generator according to the instructions in the Maintenance section.
3. Drain all fuel completely from the fuel hose and carburetor to prevent gum from forming.
4. Turn off the fuel supply at the fuel valve.
5. Change the oil.
6. Reattach the spark plug.
7. Remove the spark plug and pour about 15ml of oil into the cylinder. Crank the engine slowly to distribute the oil and lubricate the cylinder.
8. Store the unit in a clean, dry area out of direct sunlight.

Transportation

To prevent fuel spillage when transporting or during temporary storage, the generating set should be secured upright in its normal operating position, with the engine switch OFF. The fuel valve lever should be turned OFF.

WARNING:

When transporting:

DO NOT overfill the tank.
DO NOT operate the generator while it is on vehicle. Take the generator off the vehicle and use it in a well-ventilated place. Avoid a place exposed to direct sunlight when putting the generator on a vehicle. If the generator is left in an enclosed vehicle for many hours, high temperature inside the vehicle could cause fuel to vaporize resulting in a possible explosion.
DO NOT drive on a rough road for an extended period with the generator on board. If you must transport the generator on a rough road, drain the fuel from the generator beforehand.

SPECIFICATIONS

Specification Parameter Table

Engine parameter	Model	SPG7085E
	Engine model	GX390
	Displacement(cm ³)	389
	Start style	Recoil (electric start optional)
	Oil capacity(L)	1.1
Generator parameter	Frequency(Hz)	60
	Voltage(V)	120(120/240)
	Phase	Single
	Rated running power (kW)	7.0
	Rated starting power(kW)	8.5
	Power factor	1.0
	Insulation rate	F
	Fuel capacity(L)	23

Wiring Diagram for 60Hz

SPG7085E

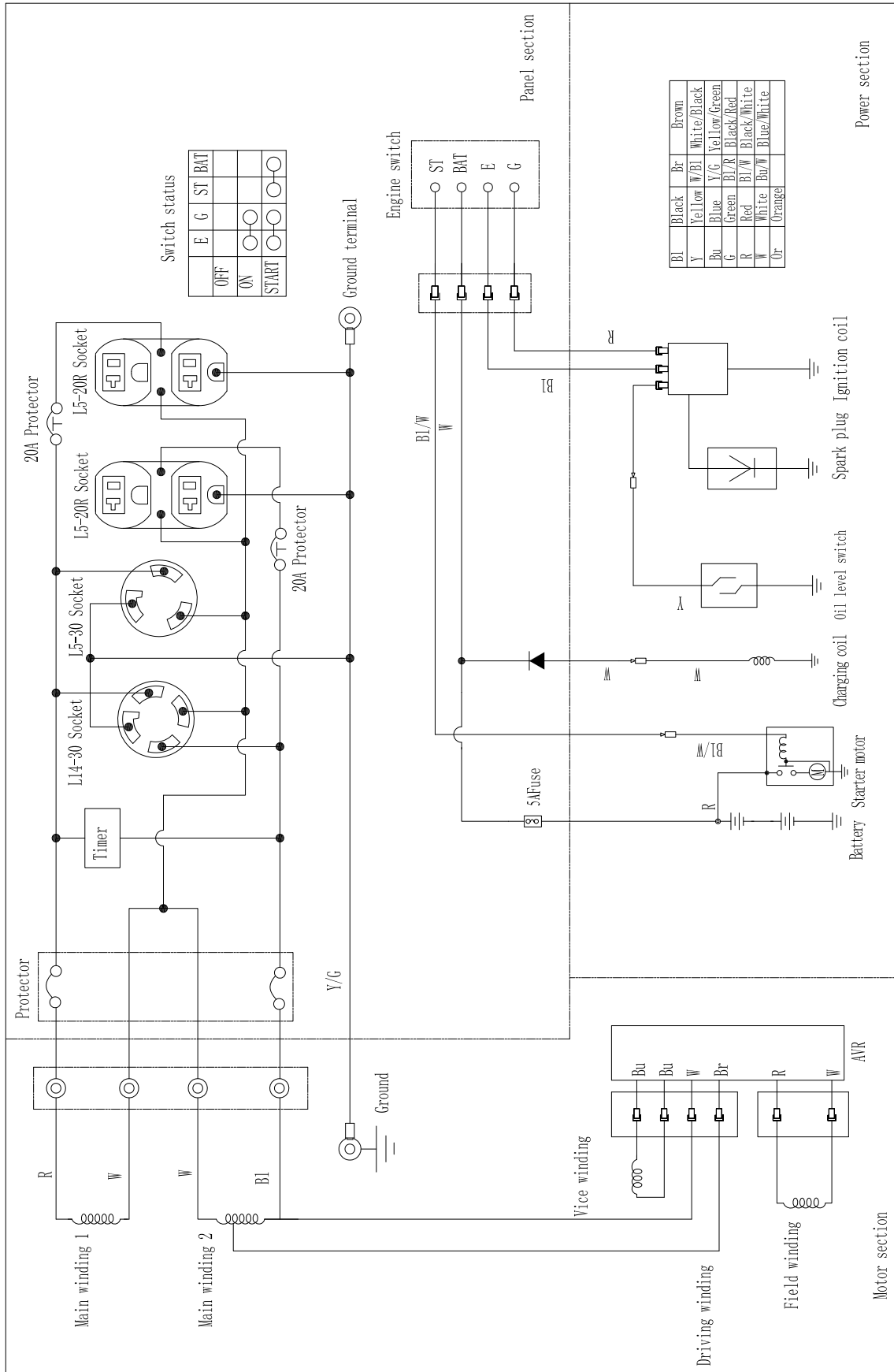

NOTE: Because of the difference of generator, the wiring diagram is only for reference.

LIMITED WARRANTY

FNA Group, warrants to the original retail purchaser that this SIMPSON brand outdoor product is free from defect in material and workmanship and agrees to repair or replace, at FNA Group's, discretion, any defective product free of charge within these time periods from the date of purchase.

Three years if the product is used for personal, family or household use;

6 months, if used for any other purpose, such as commercial or rental.

This warranty extends to the original retail purchaser only and commences on the date of the original retail purchase.

Any part of this product found in the reasonable judgment of FNA Group to be defective in material or workmanship will be repaired or replaced without charge for parts and labor by an authorized service center for SIMPSON brand outdoor products. (Authorized SIMPSON Service Center).

The product, including any defective part, must be returned to an authorized SIMPSON service center within the warranty period. The expense of delivering the product to the service center for warranty work and the expense of returning it back to the owner after repair or replacement will be paid by the owner. SIMPSON's responsibility in respect to claims is limited to making the required repairs or replacements and no claim of breach of warranty shall be cause for cancellation or rescission of the contract of sale of any SIMPSON brand outdoor product. Proof of purchase will be required by the dealer to substantiate any warranty claim. All warranty work must be performed by an authorized service center.

This warranty is limited to six (6) months from the date of original retail purchase for this product if used for rental or commercial purposes, or any other income-producing purpose.

This warranty does not cover any product that has been subject to abuse, misuse, neglect, negligence, accident, the effects of corrosion or erosion, or that has been operated in any way contrary to the operating instructions as specified in this operator's manual. This warranty does not apply to any damage to the product that is the result of improper maintenance or to any product that has been altered or modified. The warranty does not extend to repairs made necessary by normal wear or by the use of parts or accessories which are either incompatible with the SIMPSON brand outdoor product or adversely affect its operation, performance, or durability.

ALL IMPLIED WARRANTIES ARE LIMITED IN DURATION TO THE STATED WARRANTY PERIOD. ACCORDINGLY, ANY SUCH IMPLIED WARRANTIES INCLUDING MERCHANTABILITY, FITNESS FOR A PARTICULAR PURPOSE, OR OTHERWISE, ARE DISCLAIMED IN THEIR ENTIRETY AFTER THE EXPIRATION OF THE APPROPRIATE THREE-YEAR OR NINETY-DAY WARRANTY PERIOD.

SIMPSON OBLIGATION UNDER THIS WARRANTY IS STRICTLY AND EXCLUSIVELY LIMITED TO THE REPAIR OR REPLACEMENT OF DEFECTIVE PARTS AND SIMPSON DOES NOT ASSUME OR AUTHORIZE ANYONE TO ASSUME FOR THEM ANY OTHER OBLIGATION. SOME STATES DO NOT ALLOW LIMITATIONS ON HOW LONG AN IMPLIED WARRANTY LASTS, SO THE ABOVE LIMITATION MAY NOT APPLY TO YOU.

SIMPSON ASSUMES NO RESPONSIBILITY FOR INCIDENTAL, CONSEQUENTIAL, OR OTHER DAMAGES INCLUDING, BUT NOT LIMITED TO, EXPENSE OF RETURNING THE PRODUCT TO AN AUTHORIZED SIMPSON SERVICE CENTER AND EXPENSE OF DELIVERING IT BACK TO THE OWNER, MECHANIC'S TRAVEL TIME, TELEPHONE OR TELEGRAM CHARGES, RENTAL OF A LIKE PRODUCT DURING THE TIME WARRANTY SERVICE IS BEING PERFORMED, TRAVEL, LOSS OR DAMAGE TO

PERSONAL PROPERTY, LOSS OF REVENUE, LOSS OF USE OF THE PRODUCT, LOSS OF TIME, OR INCONVENIENCE. SOME STATES DO NOT ALLOW THE EXCLUSION OR LIMITATION OF INCIDENTAL OR CONSEQUENTIAL DAMAGES, SO THE ABOVE LIMITATION OR EXCLUSION MAY NOT APPLY TO YOU.

This warranty gives you specific legal rights, and you may also have other rights which vary from state to state. This warranty applies this SIMPSON brand outdoor product manufactured by or for SIMPSON's and sold in the United States and Canada.

To locate your nearest Authorized SIMPSON Service Center, dial 1-877-362-4271.