



HEARTH PRODUCTS

P/N 506017-06 Rev. B 01/2013

This manual is one of a set of two supporting this product. Refer to P/N 506015-07 for Installation Instructions. Ce manuel est disponible en français, simplement en faire la demande. Numéro de la pièce 506223-44.

CARE AND OPERATION INSTRUCTIONS

MPD Direct-Vent Gas Fireplaces

MERIT Plus SERIES

MODELS

MILLIVOLT:

Table with 2 columns: Model numbers (MPDT33RNM, MPDT33RPM, MPDR33RNM, MPDR33RPM, MPD35CNM, MPD35RNM) and Millivolt values (MPD35RPM, MPD40CNM, MPD40RNM, MPD40RPM, MPD45RNM, MPD45RPM).

ELECTRONIC:

Table with 2 columns: Model numbers (MPDT33RNE, MPDR33RNE, MPD35CNE, MPD35RNE) and Electronic values (MPD40CNE, MPD40RNE, MPD45RNE).



OTL Report No. 116-F-13g-5



Table of Contents with sections: Safety and Your Fireplace, FREE Safety Guard Offer, Important Safety Information, Attaching the Safety-in-Operation Warnings, and multilingual sections for important safety information.



INSTALLER: Leave this manual with the appliance. CONSUMER: Retain this manual for future reference. INSTALLATEUR: Laissez cette notice avec l'appareil. CONSOMMATEUR: Conservez cette notice pour consultation ultérieure.

WARNING / AVERTISSEMENT / AVISO

- HOT GLASS WILL CAUSE BURNS. • DO NOT TOUCH GLASS UNTIL COOLED. • NEVER ALLOW CHILDREN TO TOUCH GLASS. • UNE SURFACE VITRÉE CHAUDE PEUT CAUSER DES BRÛLURES. • LAISSER REFROIDIR LA SURFACE VITRÉE AVANT D'Y TOUCHER. • NE PERMETTEZ JAMAIS À UN ENFANT DE TOUCHER LA SURFACE VITRÉE. • EL VIDRIO CALIENTE CAUSARÁ QUEMADURAS. • USTED DEBE NUNCA TOCAR EL VIDRIO CALIENTE. • LOS NIÑOS DEBEN NUNCA TOCAR EL VIDRIO.

WARNING: If the information in these instructions is not followed exactly, a fire or explosion may result, causing property damage, personal injury, or death. - Do not store or use gasoline or other flammable vapors and liquids in the vicinity of this or any other appliance. - WHAT TO DO IF YOU SMELL GAS: • Do not try to light any appliance. • Do not touch any electrical switch; do not use any phone in your building. • Immediately call your gas supplier from a neighbor's phone. Follow the gas supplier's instructions. • If you cannot reach your gas supplier, call the fire department. - Installation and service must be performed by a qualified installer, service agency or the gas supplier.

AVERTISSEMENT: Assurez-vous de bien suivre les instructions données dans cette notice pour réduire au minimum le risque d'incendie ou d'explosion ou pour éviter tout dommage matériel, toute blessure ou la mort. - Ne pas entreposer ni utiliser d'essence ni d'autres vapeurs ou liquides inflammables dans le voisinage de cet appareil ou de tout autre appareil. - QUE FAIRE SI VOUS SENTEZ UNE ODEUR DE GAZ: • Ne pas tenter d'allumer d'appareil. • Ne touchez à aucun interrupteur. Ne pas vous servir des téléphones se trouvant dans le bâtiment où vous trouvez. • Appelez immédiatement votre fournisseur de gaz depuis un voisin. Suivez les instructions du fournisseur. • Si vous ne pouvez rejoindre le fournisseur de gaz, appelez le service des incendies. - L'installation et l'entretien doivent être assurés par un installateur ou un service d'entretien qualifié ou par le fournisseur de gaz.

Thank you for your purchase. We appreciate your business!
 Please carefully read and follow all instructions in this manual.
Pay special attention to all warnings and safety information.
 Following these safety, care, and operation instructions will help ensure many years of dependable and enjoyable service from your fireplace.

Register your product online today!

To help us keep you up-to-date on product information and offers, please take a few moments to register your product online at www.lennox.com (Hearth / Owner Resources).

• FREE SAFETY GUARD OFFER •

The Lennox® SAFETY GUARD protects against severe burns and injuries by preventing direct contact with the front glass surface of your fireplace.

To receive your FREE SAFETY GUARD, call 1-800-786-7976 or visit www.lennox.com (Hearth / Owner Resources).

Note: Safety Guards may not be available for some older models that are no longer in production.

Table of Contents

Safety and Your Fireplace 2

Important Safety Information 4

Attaching Safety-in-Operation Warnings 5

Appliance Installation, Service, and Maintenance Notices 6

Appliance Operation Notices 6

Warranty Information 6

General Information 6

 BTU Input 7

 Gas Pressure Requirements 7

 Orifice Sizes 7

 Burn-In Period 7

Operation and Care of Your Appliance 8

Gas Controls/Control Compartment Access 8

Variable Flame Height Adjustment 9

Maintenance 10

Front Glass Enclosure Panel, Removal and Installation 11

Install Volcanic Stone, Glowing Embers, and Logs 12

Burner Flame Appearance and Sooting 16

Burner Flame Adjustments 17

Millivolt Appliance Checkout 17

Electronic Appliance Checkout 17

Wiring Diagrams 18

Ordering Replacement Parts 18

Product Reference Information 18

Accessory Components 19

Maintenance Schedule 23

Lighting Instructions – Millivolt 24

Lighting Instructions – Electronic 26

Troubleshooting Guide – Millivolt Gas Control System 28

Troubleshooting Guide – Electronic Gas Control System 29

Replacement Parts List 30



We recommend that our gas hearth products be installed and serviced by professionals who are certified in the U.S. by the National Fireplace Institute® (NFI) as NFI Gas Specialists.

CERTIFIED
www.nficertified.org

Safety and Your Fireplace

All parts of your Lennox Hearth Products fireplace get EXTREMELY HOT!

- To prevent severe burns and injuries, install a screen or physical barrier to prevent direct contact with the glass.

To order a FREE Lennox® SAFETY GUARD for your fireplace, see details at left.

- Follow the safety instructions below and be sure everyone in your household understands this burn hazard:

- **The surfaces on your fireplace get EXTREMELY HOT!**

- **The glass on the front of the fireplace reaches EXTREMELY HIGH temperatures and can cause severe burns if touched.**



- **Keep children away from an operating fireplace. Closely supervise children in any room where a fireplace is operating to prevent contact with glass.**

- **Keep clothing, furniture, gasoline, and other flammable liquids away from the fireplace.**



- **Even after the gas is turned off, fireplace surfaces remain extremely hot.**

- Be sure to attach the enclosed **Safety-in-Operation Warnings** where you turn on your fireplace, to help remind everyone of the dangers associated with high temperatures (see page 5).

- Read **Important Safety Information** on page 4.

[FRENCH]

La sécurité et votre foyer

**Toutes les parties de votre foyer
Lennox Hearth Products deviennent
EXTRÊMEMENT CHAUDES !**

- Afin d'éviter de vous brûler gravement ou de vous blesser, installez une grille ou une barrière physique pour empêcher tout contact direct avec la vitre.

Pour commander un PANNEAU DE PROTECTION Lennox® GRATUIT pour votre foyer, consultez les détails dans la partie gauche.

- Suivez les instructions de sécurité ci-dessous et veillez à ce que tous les membres de votre famille soient conscients du danger de brûlure encouru :
 - **Les surfaces de votre foyer deviennent EXTRÊMEMENT CHAUDES !**
 - **La vitre située à l'avant du foyer atteint des températures EXTRÊMEMENT ÉLEVÉES et peut causer de graves blessures en cas de contact.**
 - **Tenez les enfants à l'écart du foyer lorsqu'il fonctionne. Surveillez attentivement les enfants dans les pièces où un foyer est utilisé afin d'éviter qu'ils ne soient en contact avec la vitre.**
 - **Tenez tous les vêtements, les meubles, l'essence et tout autre liquide inflammable à l'écart du foyer.**
 - **Même après fermeture du gaz, les surfaces du foyer restent extrêmement chaudes.**
- Veillez à coller les **Étiquettes de mise en garde relatives à la sécurité d'utilisation** à l'endroit où vous utilisez le foyer, pour rappeler à tous les utilisateurs les dangers liés aux températures élevées (**voir page 5**).
- Lisez la section **Informations importantes relatives à la sécurité, page 4.**

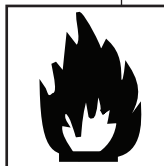

[SPANISH]

Seguridad y su chimenea

**¡Todas las partes de la chimenea
Lennox Hearth Products se ponen
MUY CALIENTES!**

- Instale una malla o barrera física para evitar el contacto directo con el vidrio y prevenir las quemaduras y lesiones graves.

Ver los detalles a la izquierda para ordenar un Lennox® SAFETY GUARD GRATIS para su chimenea.

- Siga las instrucciones de seguridad a continuación y asegúrese de que todos en su hogar sepan acerca de este peligro de quemadura:
 - **¡Las superficies de la chimenea se ponen MUY CALIENTES!**
 - **El vidrio delante de la chimenea alcanza temperaturas EXTREMADAMENTE ALTAS y puede causar quemaduras graves si se toca.**
 - **Mantenga a los niños alejados de la chimenea en funcionamiento. Supervise en forma cercana a los niños en cualquier cuarto donde haya una chimenea funcionando para impedir el contacto con el vidrio.**
 - **Mantenga la ropa, mobiliario, gasolina y otros líquidos inflamables alejados de la chimenea.**
 - **Aún después de haber apagado el gas, las superficies de la chimenea permanecen extremadamente calientes.**
- Asegúrese de colocar las **Etiquetas de advertencia de seguridad de operación** en el lugar donde enciende la chimenea, para que todos recuerden los peligros asociados con las altas temperaturas (**ver la página 5**).
- Lea la **Información importante** de seguridad en la **página 4.**

Important Safety Information

1. **WARNING:** Do not operate appliance with the glass front removed, cracked or broken.
2. Do not use this appliance if any part has been under water. Immediately call a qualified service technician to inspect the appliance and to replace any part of the control system and any gas control which has been under water.
3. Due to high temperatures, the appliance should be located out of traffic and away from furniture and draperies.
4. Children and adults should be alerted to the hazards of high surface temperature and should stay away to avoid burns or clothing ignition.
5. Clothing or other flammable material should not be placed on or near the appliance.
6. Young children should be carefully supervised when they are in the same room as the appliance. Toddlers, young children, and others may be susceptible to accidental contact burns. A physical barrier is recommended if there are at-risk individuals in the house. To restrict access to a fireplace or stove, install an adjustable safety gate to keep toddlers, young children, and other at-risk individuals out of the room and away from hot surfaces.
7. Any safety screen or guard removed for servicing an appliance must be replaced prior to operating the appliance.
8. Installation and repair should be done by a qualified service person. The appliance should be inspected before use and at least annually by a professional service person. More frequent cleaning may be required due to excessive lint from carpeting, bedding material, et cetera. It is imperative that control compartments, burners, and circulating air passageways of the appliance be kept clean. See maintenance instructions on page 10.

L'information de sûreté importante

1. **AVERTISSEMENT.** Ne pas utiliser l'appareil si le panneau frontal en verre n'est pas en place, est craqué ou brisé.
2. Ne pas utiliser cet appareil s'il a été plongé, même partiellement, dans l'eau. Appeler un technicien qualifié pour inspecter l'appareil et remplacer toute partie du système de commande et toute commande qui a été plongée dans l'eau.
3. En raison des températures élevées, l'appareil devrait être installé dans un endroit où il y a peu de circulation et loin du mobilier et des tentures.
4. Les enfants et les adultes devraient être informés des dangers que posent les températures de surface élevées et se tenir à distance afin d'éviter des brûlures ou que leurs vêtements ne s'enflamment.
5. On ne devrait pas placer de vêtements ni d'autres matières inflammables sur l'appareil ni à proximité.
6. Les jeunes enfants devraient être surveillés étroitement lorsqu'ils se trouvent dans la même pièce que l'appareil. Les tout petits, les jeunes enfants ou les adultes peuvent subir des brûlures s'ils viennent en contact avec la surface chaude. Il est recommandé d'installer une barrière physique si des personnes à risques habitent la maison. Pour empêcher l'accès à un foyer ou à un poêle, installez une barrière de sécurité ; cette mesure empêchera les tout petits, les jeunes enfants et toute autre personne à risque d'avoir accès à la pièce et aux surfaces chaudes.
7. Tout écran ou protecteur retiré pour permettre l'entretien de l'appareil doit être remis en place avant de mettre l'appareil en marche.
8. L'installation et la réparation devrait être confiées à un technicien qualifié. L'appareil devrait faire l'objet d'une inspection par un technicien professionnel avant d'être utilisé et au moins une fois l'an par la suite. Des nettoyages plus fréquents peuvent être nécessaires si les tapis, la literie, et cetera produisent une quantité importante de poussière. Il est essentiel que les compartiments abritant les commandes, les brûleurs et les conduits de circulation d'air de l'appareil soient tenus propres. Voyez les instructions d'entretien à la page 10.

[SPANISH]

Información importante de seguridad

1. **ADVERTENCIA:** No opere el artefacto con el frente de vidrio quitado, agrietado o roto.
2. No use este artefacto si alguna de sus partes ha estado bajo agua. Llame de inmediato a un técnico de servicio calificado para que inspeccione el artefacto y reemplace cualquier parte del sistema de control y cualquier control de gas que haya estado bajo agua.
3. Debido a las altas temperaturas, el artefacto debe situarse fuera de las áreas de tráfico y lejos del mobiliario y cortinas.
4. Se debe alertar a los niños y adultos sobre los peligros de las altas temperaturas en la superficie y que se mantengan alejados para evitar quemaduras o ignición de la ropa.
5. No debe colocarse ropa u otros materiales inflamables sobre y cerca del artefacto.

6. Se debe supervisar de cerca a los niños cuando estén en el mismo cuarto que el artefacto. Los niños pequeños, los jóvenes y otras personas pueden ser susceptibles a quemaduras por contacto accidental. Se recomienda instalar una barrera física si hay personas en riesgo en la casa. Para restringir el acceso a una chimenea o estufa, instale una puerta de seguridad ajustable para mantener a los niños pequeños, jóvenes y otras personas en riesgo fuera del cuarto y lejos de las superficies calientes.
7. Cualquier malla o resguardo de seguridad quitado para dar servicio a un artefacto, debe reinstalarse antes de operar el artefacto.
8. Una persona de servicio competente debe realizar la instalación y reparación. Una persona de servicio profesional debe inspeccionar el artefacto antes de usar al menos una vez por año. Se puede requerir limpieza más frecuente debido a la pelusa excesiva del alfombrado, del material de cobijas, etc. Es imprescindible mantener limpios los compartimientos de control, los quemadores y los pasajes de circulación del aire del artefacto. Ver las instrucciones de mantenimiento en la página 10.

HOMEOWNER'S INSTRUCTIONS—ATTACHING SAFETY-IN-OPERATION WARNINGS

ATTACHING SAFETY-IN-OPERATION WARNINGS

Your fireplace has been furnished with safety instruction labels that are to be affixed to the operation and control point of the fireplace. A safety instruction label should be affixed to the wall switch plate where the fireplace is turned on and off (*See Figure A*) or wall thermostat (*See Figure B*) and if used on the remote control handheld transmitter (*Figure C*). The warnings should already have been put in place when the fireplace initial set-up was completed. If they are not affixed at these spots, locate the multi-lingual adhesive labels provided with these instructions and proceed as follows:

1. Locate the wall switch or wall thermostat that controls the fireplace (verify the switch operates the fireplace by turning it on and off). Clean the wall switch plate or wall thermostat thoroughly to remove any dust and oils. Affix the label to the surface of the plate of the wall switch that controls the fireplace (*Figure A*) or the wall thermostat (*Figure B*). Choose the language primarily spoken in the home.
2. If a remote control is used to control the fireplace, locate the transmitter and clean it thoroughly to remove any dust and oils. Affix the label to the surface of handheld transmitter (*Figure C*). Choose the language primarily spoken in the home.
3. If you are unable to locate the labels, please call Lennox Hearth Products or your nearest Lennox Hearth Products dealer to receive additional safety instruction labels free of charge.

Cat. No. H8024 Replacement Label Kit

LENNOX HEARTH PRODUCTS
1-800-655-2008

Note: English is red text on clear label. French and Spanish are white text on black label.

SAFETY LABEL DIAGRAMS



APPOSITION DES MISES EN GARDE RELATIVES À LA SÉCURITÉ D'UTILISATION

Votre foyer a été livré avec des étiquettes de sécurité qui doivent être collées à côté des dispositifs de contrôle du foyer. Une étiquette de sécurité doit être collée sur la plaque de l'interrupteur contrôlant l'allumage du foyer (*voir Figure A*) ou sur le thermostat mural (*voir Figure B*) et, le cas échéant, sur le boîtier de la télécommande (*Figure C*). Les mises en garde auraient dû être collées au moment de l'installation initiale du foyer. Si ce n'est pas le cas, prenez les étiquettes adhésives multilingues fournies avec ces instructions et procédez comme suit:

1. Repérez l'interrupteur ou le thermostat mural qui contrôle le foyer (vérifiez que l'interrupteur contrôle le fonctionnement du foyer en le faisant basculer de Marche à Arrêt, et vice-versa). Nettoyez soigneusement la plaque murale de l'interrupteur ou le thermostat mural pour éliminer la poussière et les traces de graisse ou d'huile. Collez l'étiquette sur la surface de la plaque de l'interrupteur mural qui contrôle le foyer (*Figure A*) ou du thermostat mural (*Figure B*). Choisissez la langue qui est principalement parlée dans la résidence du propriétaire.
2. Si une télécommande est utilisée pour contrôler le foyer, nettoyez la soigneusement pour éliminer la poussière et les traces de graisse ou d'huile. Collez l'étiquette sur le boîtier de la télécommande (*Figure C*). Choisissez la langue qui est principalement parlée dans la résidence du propriétaire.
3. Si vous ne trouvez pas les étiquettes, veuillez appeler Lennox Hearth Products ou votre distributeur Lennox Hearth Products local pour recevoir gratuitement des étiquettes supplémentaires.

Étiquettes de remplacement, n° cat. H8024

LENNOX HEARTH PRODUCTS
1-800-655-2008

Remarque : Le texte anglais est rouge sur un support transparent. Le texte français et espagnol est blanc sur un support noir.

DIAGRAMMES DES ÉTIQUETTES DE SÉCURITÉ



COLOCACIÓN DE ADVERTENCIAS DE SEGURIDAD EN OPERACIÓN

Su chimenea incluye etiquetas de instrucciones de seguridad que deben colocarse en el punto de operación y control de la chimenea. Se debe colocar una etiqueta de instrucciones de seguridad en la placa del interruptor de pared desde el cual se enciende y se apaga la chimenea (*ver la Figura A*) o en el termostato de pared (*ver la Figura B*) y en el transmisor de control remoto (*Figura C*) si se usa. Las advertencias ya deben haberse colocado cuando se completó la instalación inicial de la chimenea. Si no están colocadas en estos lugares, encuentre las etiquetas adhesivas multilingües proporcionadas con estas instrucciones y prosiga de la siguiente manera:

1. Identifique el interruptor o el termostato de pared que controla la chimenea (verifique que el interruptor opera la chimenea encendiéndola y apagándola). Limpie bien la placa del interruptor o el termostato de pared para quitar el polvo y aceite. Pegue la etiqueta en la superficie de la placa del interruptor que controla la chimenea (*Figura A*) o en el termostato de pared (*Figura B*). Seleccione el idioma que más se habla en la casa.
2. Si se usa un control remoto para controlar la chimenea, encuentre el transmisor y límpielo bien para quitar el polvo y aceite. Pegue la etiqueta en la superficie del transmisor (*Figura C*). Seleccione el idioma que más se habla en la casa.
3. Si no puede encontrar las etiquetas, sírvase llamar a Lennox Hearth Products o al distribuidor de Lennox Hearth Products más cercano para recibir etiquetas de instrucciones de seguridad adicionales gratuitas.

Juego de etiquetas de repuesto - N° de cat. H8024

LENNOX HEARTH PRODUCTS
1-800-655-2008

Nota: La etiqueta en inglés es transparente con texto rojo. Las etiquetas en francés y español son negras con texto blanco.

DIAGRAMAS DE ETIQUETAS DE SEGURIDAD



Figure A



Figure B



Figure C



NOTE: DIAGRAMS & ILLUSTRATIONS ARE NOT TO SCALE.

Illustrations are for example only. Your accessories may be different. / Les illustrations sont par exemple uniquement. Vos accessoires peuvent être différents. / Las ilustraciones son sólo ejemplos. Tu accesorios pueden ser diferentes.

APPLIANCE INSTALLATION, SERVICE, AND MAINTENANCE NOTICES

WARNING: Improper installation, adjustment, alteration, service or maintenance can cause injury or property damage. Refer to the owner's information manual provided with this appliance. For assistance or additional information consult a qualified installer, service agency or the gas supplier.

AVERTISSEMENT : Une installation, un réglage, une modification, une réparation ou un entretien mal effectué peut causer des dommages matériels ou des blessures. Voir la notice de l'utilisateur qui accompagne l'appareil. Pour de l'aide ou des renseignements supplémentaires, consultez un installateur, un technicien agréé ou le fournisseur de gaz.

Only trim kit(s) supplied by the manufacturer shall be used in the installation of this appliance.

Seules les trousse de garniture fournies par le fabricant doivent être utilisées pour l'installation de cet appareil.

These appliances must not be connected to a chimney or flue serving a separate solid fuel burning appliance.

Any change to this appliance and/or its operating controls is dangerous. Improper installation or use of this appliance can cause serious injury or death from fire, burns, explosion or carbon monoxide poisoning.

CARBON MONOXIDE POISONING

Early signs of carbon monoxide poisoning are similar to the flu with headaches, dizziness and/or nausea. If you have these signs, obtain fresh air immediately. Turn off the gas supply to the appliance and have it serviced by a qualified professional, as it may not be operating correctly. Some people are more affected by carbon monoxide than others, including pregnant women, people with heart or lung disease or anemia, those under the influence of alcohol, and those at high altitudes. Turn off gas and electrical power to the fireplace and allow it to cool before cleaning or servicing the appliance.

The vent termination is hot while in operation and for a period of time following the use of the fireplace.

Young children should be carefully supervised when they are in the same area as a hot termination.

APPLIANCE OPERATION NOTICES

Do not operate appliance with the glass front removed, cracked, or broken.

These fireplaces are vented gas appliances. Do not burn wood or other material in these appliances.

This appliance is only for use with the type of gas indicated on rating plate.

This appliance is not convertible for use with other gases, unless a certified kit is used.

These appliances are designed to operate on natural gas or propane gas only. The use of other fuels or combinations of fuels will degrade the performance of this system and may be dangerous.

Cet appareil doit être utilisé uniquement avec les types de gaz indiqués sur la plaque signalétique.

Ne pas l'utiliser avec d'autres gaz sauf si un kit de conversion certifié est installé.

Provide adequate clearances around air openings and adequate accessibility clearance for service and proper operation. Never obstruct the front openings of the appliance.

Do not use this appliance if any part has been under water. Immediately call a qualified service technician to inspect the appliance and to replace any part of the control system and any gas control that has been under water.

These fireplaces are designed as supplemental heaters. Therefore, it is advisable to have an alternate primary heat source when installed in a dwelling.

CAUTION: Hot while in operation. Do not touch. Severe Burns may result. Keep children, clothing furniture, gasoline and other liquids having flammable vapors away.

ATTENTION : L'appareil est chaud lorsqu'il fonctionne. Ne pas toucher l'appareil. Risque de brûlures graves. Surveiller les enfants. Garder les vêtements, les meubles, l'essence ou autres liquides produisant des vapeurs inflammables loin de l'appareil.

WARRANTY INFORMATION

Your gas appliance is covered by a limited twenty-year warranty. You will find a copy of the warranty accompanying this manual. Please read the warranty to be familiar with its coverage.

Retain this manual. File it with your other documents for future reference.

Failure to comply with the installation and operating instructions provided will result in an improperly installed and operating appliance, voiding its warranty.

Do not attempt to alter or modify the construction of the appliance or its components. Any modification or alteration may void the warranty, certification, and listings of this unit.

GENERAL INFORMATION

The fireplace models covered in this manual are direct-vent sealed combustion gas fireplace heaters designed for residential application. These direct-vent appliances operate with the combustion chamber completely isolated from the indoor environment.

All air for combustion is brought in from the outside and exhaust gases are vented through the same direct-vent, co-axial (intake/exhaust) vent system.

The Millivolt appliances have a millivolt gas control valve with piezo ignition system. If any optional accessories that will require electrical power are to be installed, the electrical power must be provided at the time of appliance installation.

The Electronic appliances are designed to operate on natural or propane gas. An electronic intermittent pilot ignition system provides safe, efficient operation. External electrical power is required to operate these units. During a power outage the fireplace may be operated using the battery backup.

These appliances comply with National Safety Standards and are tested and listed by OMNI-Test Laboratories, Inc. (Report No. 116-F-13g-5) to ANSI Z221.88-2009 (in Canada, CSA-2.33-2009), and CAN/CGA-2.17-M91 (R2009) in both USA and Canada, as vented gas fireplace heaters.

The Installation must conform to local codes or, in the absence of local codes, with the National Fuel Gas Code, ANSI Z223.1-2009 / NFPA 54—latest edition, or the Natural Gas and Propane Installation Code, CAN/CSA B149.1—latest edition. The appliance, when installed, must be electrically grounded in accordance with local codes or, in the absence of local codes, the latest edition of the National Electrical Code, ANSI/NFPA 70, or the Canadian Electrical Code, CSA C22.1—latest editions.

**GENERAL INFORMATION (continued)
BTU Input**

Millivolt appliances are manually controlled and feature a spark igniter (piezo) that allows the appliance pilot gas to be lit without the use of matches or batteries. This system provides continued service in the event of a power outage.

Millivolt models come standard with a manually-modulated gas valve. Flame appearance and heat output can be controlled at the gas valve.

Both millivolt and electronic systems can be operated during a power outage, and feature manually operated hi-low flame control. The BTU Input for these appliances is shown in **Table 1**.

Models	Input Rate (BTU/HR)	
	Nat. Gas	Prop. Gas
MPD33	17,500 high 11,700 low	17,500 high 14,000 low
MPD35	20,000 high 12,800 low	20,000 high 15,200 low
MPD40	27,000 high 18,500 low	27,000 high 21,500 low
MPD45	29,000 high 20,500 low	29,000 high 22,500 low

Table 1: Input (BTU/HR) Gas Valves (Millivolt and Electronic)

Gas Pressure—All Models

Tables 2 and 3 show the appliances' inlet and manifold gas pressure requirements:

Fuel #	Minimum	Maximum
Natural Gas	4.5 in. WC (1.12 kPa)	10.5 in. WC (2.61 kPa)
Propane	11.0 in. WC (2.74 kPa)	13.0 in. WC (3.23 kPa)

Table 2: Inlet Gas Supply Pressure

Fuel #	Low	High
Natural Gas	1.6 in. WC (0.40 kPa)	3.5 in. WC (0.87 kPa)
Propane	6.3 in. WC (1.57 kPa)	10.0 in. WC (2.49 kPa)

Table 3: Manifold Gas Supply Pressure

Test gauge connections are provided on the front of the millivolt and electronic gas control valve (identified IN for the inlet and OUT for the manifold side). The control valves have a 3/8 in. (10mm) NPT thread inlet and outlet side of the valve (refer to **Figures 1 and 2**).

Propane tanks are at pressures that will cause damage to valve components. Verify that the tanks have step down regulators to reduce the pressure to safe levels.

The appliance and its appliance main gas valve must be disconnected from the gas supply piping system during any pressure testing of that system at test pressures **in excess of** 1/2 psi (3.5 kPa).

The appliance must be isolated from the gas supply piping system by closing its equipment shutoff valve during any pressure testing of the gas supply piping system at test pressures **equal to or less than** 1/2 psi (3.5 kPa).

Orifice Sizes—Sea Level to High Altitude (All Models)

These appliances are tested and approved for installation at elevations of 0-4500 feet (0-1372 meters) above sea level using the standard burner orifice sizes (marked with an "*" in **Table 4**).

For elevations above 4500 feet, contact your gas supplier or qualified service technician.

Model Series	Nat. Gas drill size (inches)	Propane drill size (inches)
MPD33	#47 (0.0785 in.)* 99K74•	0.048 in. 99K78•
MPD35	#44 (0.086 in.)* 60J80•	#55 (0.052 in.)* 19L52•
MPD40	#38 (0.102 in.)* 99K76•	0.062 in. 21L01•
MPD45	#37 (0.104 in.)* 24M10•	#52 (0.0635 in.)* 37G00•

* Standard size installed at factory
• Part/Cat. Number

Table 4: Burner Orifice Sizes Elevation 0-4500 ft (0-1372 m)

Deration—At higher elevations, the amount of BTU fuel value delivered must be reduced by either using gas that has been derated by the gas company or by changing the burner orifice to a smaller size as regulated by the local authorities having jurisdiction and by the (USA) National Fuel Gas Code NFPA 54—latest edition / ANSI Z223.1-2009 or, in Canada, the CAN/CSA-B149.1 codes—latest edition.

Install the appliance according to the regulations of the local authorities having jurisdiction and, in the USA, the National Fuel Gas Code NFPA 54—latest edition / ANSI Z223.1-2009 or, in Canada, the CAN/CSA-B149.1—latest edition.

Flame breadth, height and width will diminish 4% for every 1,000 feet of altitude.

In Canada - CAN/CGA-2.17-M91 (R2009) (high altitude):

THE CONVERSION SHALL BE CARRIED OUT BY A MANUFACTURER'S AUTHORIZED REPRESENTATIVE, IN ACCORDANCE WITH THE REQUIREMENTS OF THE MANUFACTURER, PROVINCIAL OR TERRITORIAL AUTHORITIES HAVING JURISDICTION AND IN ACCORDANCE WITH THE REQUIREMENTS OF THE CAN/CGA-B149.1 OR CAN/CGA-B149.2 INSTALLATION CODES.

Burn-in Period

During the first few fires of this appliance there will be some odor due to the curing of the paint and burning off of lubricants used in the manufacturing process. Depending on your use, the burn-in period may take a few hours or a few days.

KEEP YOUR HOUSE WELL VENTILATED DURING THE CURING PROCESS. THE ODOR AND HAZE EMITTED DURING THE CURING PROCESS CAN BE QUITE NOTICEABLE AND MAY SET OFF A SMOKE DETECTOR.

If an optional blower is installed, do not turn it on during the burn-in period.

NOTICE: A white film may develop on the glass enclosure panel during the first few fires as part of the burn-in process.

The first few times you use the fireplace, clean the glass after each use (AFTER THE GLASS HAS COMPLETELY COOLED); otherwise, the white film will bake onto the glass and become difficult to remove.

See glass cleaning instructions on **Page 10**.

OPERATION AND CARE OF YOUR APPLIANCE

! WARNING

Young children should be carefully supervised when they are in the same room as the appliance. Toddlers, young children and others may be susceptible to accidental contact burns. A physical barrier is recommended if there are at risk individuals in the house. To restrict access to a fireplace or stove, install an adjustable safety gate to keep toddlers, young children and other at risk individuals out of the room and away from hot surfaces.

! AVERTISSEMENT

Les jeunes enfants devraient être surveillés étroitement lorsqu'ils se trouvent dans la même pièce que l'appareil. Les tout petits, les jeunes enfants ou les adultes peuvent subir des brûlures s'ils viennent en contact avec la surface chaude. Il est recommandé d'installer une barrière physique si des personnes à risques habitent la maison. Pour empêcher l'accès à un foyer ou à un poêle, installez une barrière de sécurité; cette mesure empêchera les tout petits, les jeunes enfants et toute autre personne à risque d'avoir accès à la pièce et aux surfaces chaudes.

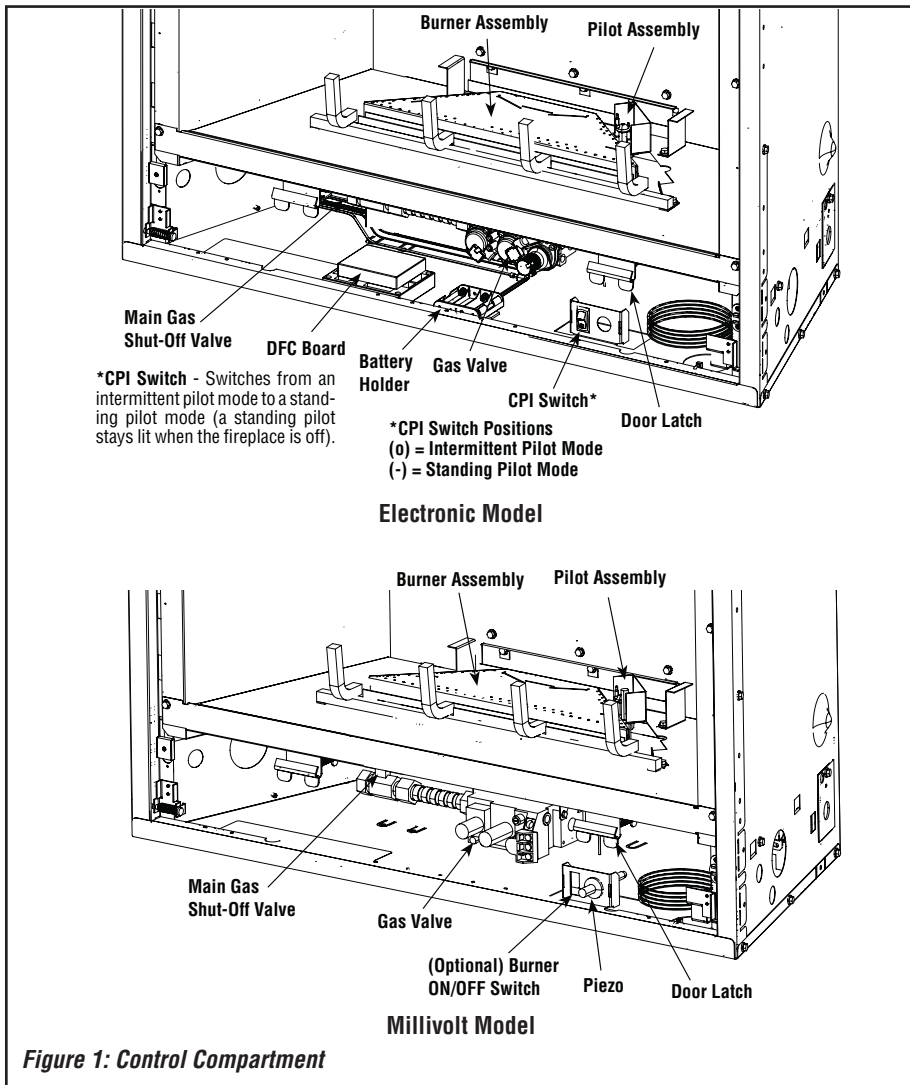

Figure 1: Control Compartment

Gas Controls/Control Compartment Access

Operation of millivolt and electronic gas control systems is different. Before lighting and operating your appliance, determine whether you have a millivolt or electronic appliance.

The gas controls can be found behind the lower access panel.

To open the panel, press the upper right corner of the panel until the spring-loaded magnetic catch is released. Then gently pull the panel forward to release the left magnetic catch and allow the panel to swing down to open.

On millivolt systems, the piezo igniter, Hi/Lo flame adjustment knob, pilot and main gas ON/OFF control knob, and gas valve (Figure 1) are located behind the lower access panel.

On electronic systems, the hi/lo flame adjustment knob and gas valve are located behind the lower access panel. To remove the lower access panel, slide the hinge pin on the left side of the panel to the RIGHT until it disengages from the left corner post hole. Pull the panel diagonally to the LEFT, away from the fireplace.

To ease panel replacement, press the spring-loaded catches to temporarily lock them in their retracted position, and then close the panel.

Refer to Figure 1 for access to the gas control valve. Millivolt appliances will be fitted with the gas control valve shown in Figure 2.

Appliances with electronic systems will be fitted with the electronic valve shown in Figure 3. Familiarize yourself with the gas control valve that your appliance uses.

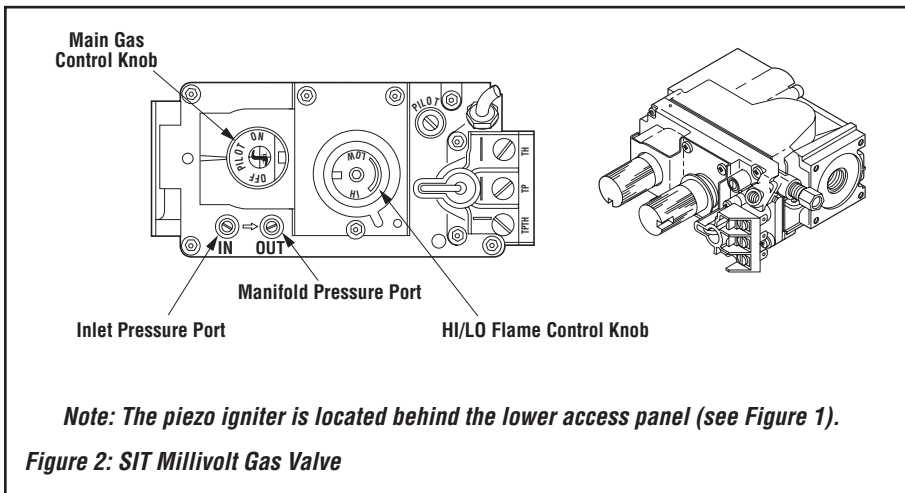

Variable Flame Height Adjustment

All Millivolt and electronic appliances are equipped with a variable gas control valve. Flame height for these models may be adjusted through a range between fixed low and high settings, alternately, while the appliance is in operation.

Adjust the flame height as desired after lighting the appliance by rotating the variable adjustment control knob located on the front of the valve (refer to **Figure 2**).

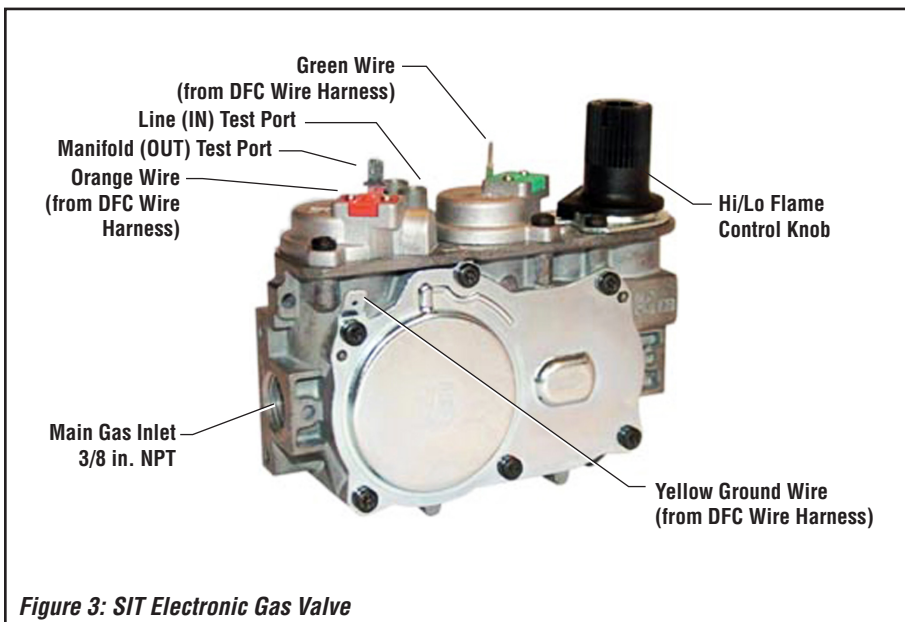

Millivolt Appliances

To light millivolt appliances, refer to the detailed lighting instructions found on **Page 26 (English) and Page 27 (French)**. **Millivolt appliance lighting instructions may also be found on the pull-out lighting instruction labels attached to the gas control valve.**

Millivolt units are not provided with any factory-installed controls; therefore, one of the optional control switches is required to operate the unit (ON/OFF Wall Switch, Unit-Mountable ON/OFF Switch, Thermostat, Remote Control). See "Accessories" in this manual for details.

Once the pilot is lit, use the switch or remote control to turn the appliance on or off.

Electronic Appliances

To light electronic appliances, refer to the detailed lighting instructions on **Page 28 (English) and Page 29 (French)**. **Electronic appliance lighting instructions may also be found on the pull-out lighting instruction label attached to the gas control valve.**

If your electronic appliance is equipped with an optional wall switch or remote control kit, the appliance main burner may be turned ON and OFF using the wall switch or remote control.

CPI switch located to the left of the gas valve switches the pilot from intermittent operation (pilot goes out when the fireplace is turned off) to continuous pilot mode. The rocker switch will not turn the burner on or off.

MAINTENANCE**(See Maintenance Schedule, Page 25)**

Refer to the maintenance schedule for maintenance tasks, procedures, frequency and by whom they should be performed. Always verify proper operation of the appliance after servicing.

 **WARNING**

Turn off gas and electrical power to the fireplace and allow it to cool before cleaning or servicing the appliance.

CAUTION: Wear gloves and safety glasses for protection while doing required maintenance.

Verify proper operation after servicing.

S'assurer que l'appareil fonctionne adéquatement une fois l'entretien terminé.

Always turn off gas to the pilot (millivolt appliances) before cleaning. Before re-lighting, refer to the lighting instructions in this manual. Instructions are also found on a pull-out panel located on the floor of the appliance.

Always keep the appliance area clear and free from combustible materials, gasoline and other flammable liquids.

Remember, Millivolt appliances have a continuous burning pilot flame. Exercise caution when using products with combustible vapors.

Inspect Venting System

The appliance and venting system should be thoroughly inspected before initial use and at least annually by a qualified service technician (inspection should include ensuring that exhaust or intake passages are unobstructed and vent components are properly assembled and not damaged).

Homeowner must contact a qualified service technician at once if any abnormal condition is observed.

If the venting system is disassembled for any reason, a qualified service technician should follow vent installation instructions for proper reassembly and proper sealing of the venting system components. However, more frequent periodic inspections and cleanings should be performed by the homeowner.

Cleaning Glass

(see *Front Glass Enclosure Panel, Removal and Installation* on **Page 11**).

Note: Clean glass after first two weeks of operation (after Burn-In period is over) and then only when necessary and when the fireplace is cool. Wipe surface with a clean, dampened, soft cloth. Follow with a dry, soft towel as desired. Take care not to scratch the glass surface.

WARNING: Do not use abrasive cleaners on glass. Never clean the glass when it is hot.

The viewing glass should be cleaned periodically to remove any build-up caused from the following:

- During start-up, it is normal for condensation to form on the inside of the glass (this condensation and fog will usually disappear in a few minutes). The moisture can cause lint, dust and other airborne particles to cling to the glass surface.
- Initial curing of the high temperature paint and burning off of lubricants used in the manufacturing process may result in a film on the glass.
- A white coating may form on the glass as a result of impurities and minerals in the fuel.

It is recommended that the glass be cleaned two or three times during each heating season, depending on the circumstances present. The following cleaning solutions are approved for use to clean glass:

- Non-ammonia based household cleaner
- 50%-50% mix of white vinegar and water
- Gas fireplace/stove glass cleaner

Inspect Glass Gasket

Visually inspect the gasket on the backside of the glass enclosure panels. The gasket surface must be clean, free of irregularities and seated firmly.

Clean Control Compartment

Keep control compartment clean by vacuuming or brushing at least twice a year. More frequent cleaning may be required due to excessive lint from carpeting, bedding materials, etc. It is important that control compartments, burners and circulating air passageways of the appliance be kept clean.

Clean Logs And Burner

Carefully remove the logs (use care when handling the fiber logs, as they become quite fragile after curing). Vacuum out any foreign matter (lint, carbon, etc.) on the burner. Ensure the burner ports are "open." Remove any carbon deposits from the under side of the logs using a vacuum cleaner, or a soft bristled brush (i.e. paint brush).

Note: Improper positioning of logs can create carbon build-up and will alter the performance of the appliance.

Replacing Logs

If the logs become damaged by accident or improper handling and need replacement, use only the proper replacement logs from manufacturer (see **Pages 13, 14 and 15** for ordering information).

Reinstall Embers and Logs

Carefully follow placement instructions on **Pages 12 through 15**. All logs should fit onto corresponding pins and/or log stoppers. This will ensure a proper flame and safe combustion.

Inspect Wiring

Refer to wiring diagrams on **Page 18**.

CAUTION: Label all wires prior to disconnection when servicing controls. Wiring errors can cause improper and dangerous operation. Verify proper operation after servicing.

ATTENTION: Au moment de l'entretien des commandes, étiquetez tous les fils avant de les débrancher. Des erreurs de câblage peuvent entraîner un fonctionnement inadéquat et dangereux.

Inspect and clean all wire connections. Ensure that there is no melting or damage. Inspection should include:

- Terminals at the Valve
- CPI Switch (Pilot Mode)
- (Optional Control Switch) Wall Thermostat, Remote Control or Remote Wall Switch Kit

Inspect Burner Flame and Pilot Flame Appearance

Periodically do a visual check of the burner and pilot flames.

See *Burner Flame Appearance* on **Page 16**.

See *Pilot Flame Appearance* on **Page 17**.

Contact a qualified service technician at once if any abnormal condition is observed.

Small Area Paint Touch-up

Only use a factory supplied paint kit for touch-ups. Paint is available at your local Lennox Hearth Products dealer. Never attempt to paint a hot fireplace.

Do not attempt to repaint the appliance until the finish is completely cured (see *Burn-In Period* on **Page 4**). If the surface later becomes stained or marred, it may be lightly sanded and touched up with spray paint.

Front Glass Enclosure Panel, Removal and Installation

! WARNING

- Do not attempt to substitute the materials used on this door, or replace cracked or broken glass.
- Handle this glass with extreme care! Glass is susceptible to damage – Do not scratch or handle roughly while reinstalling the glass door frame.
- The glass door of this appliance must only be replaced as a complete unit as provided by the manufacturer. Do not attempt to replace broken, cracked or chipped glass separately.
- Do not attempt to touch the front enclosure glass with your hands while the fireplace is in use.

! WARNING

Do not operate appliance with the glass front removed, cracked or broken.

! AVERTISSEMENT

Ne pas utiliser l'appareil si le panneau frontal en verre n'est pas en place, est craqué ou brisé.

! WARNING

Any safety screen or guard removed for servicing the appliance must be replaced prior to operating the appliance.

! AVERTISSEMENT

Tout écran ou protecteur retiré pour permettre l'entretien de l'appareil doit être remis en place avant de mettre l'appareil en marche.

Only doors certified with the appliance shall be used.

Seules des portes certifiées pour cet appareil doivent être utilisées.

WARNING: DO NOT abuse glass door by striking or slamming shut.

These are direct-vent appliances. They are designed to operate only when the front glass enclosure panels are installed. Generally the front glass enclosure panel should not be removed except to gain access to the components within the firebox.

Removing Glass Enclosure Panels (see Figure 4)

Remove the top louver assembly or radiant panel.

To access the glass door securing latches, first open the lower control compartment door (Figure 4) by pushing in simultaneously the left and right top corners of the door. (The door is hinged at the bottom.) Remove the bottom compartment door by sliding the hinge pin, located at the door's left side, to the right until it disengages from the left corner post hole. Pull the door diagonally to the left, away from the fireplace.

Locate the two (2) latches at the top of the control compartment and disengage them from the door frame bottom vee-flange, pulling down on their handles to open them.

REINSTALLING THE GLASS ENCLOSURE PANEL

Retrieve the glass door. Visually inspect the gasket on the backside of the frame. Gasket surface must be clean, free of irregularities and seated firmly.

Position the door in front of the firebox opening with the bottom of the door held away from the fireplace (Figure 4). Hook the top flange of the door frame over the top of the firebox frame.

Let the bottom of the door frame swing gently in towards the fireplace ensuring that the gasket seats evenly as the door frame draws shut. Fasten the two latches located underneath the firebox floor to the door's vee-flange. Close both the latches securely.

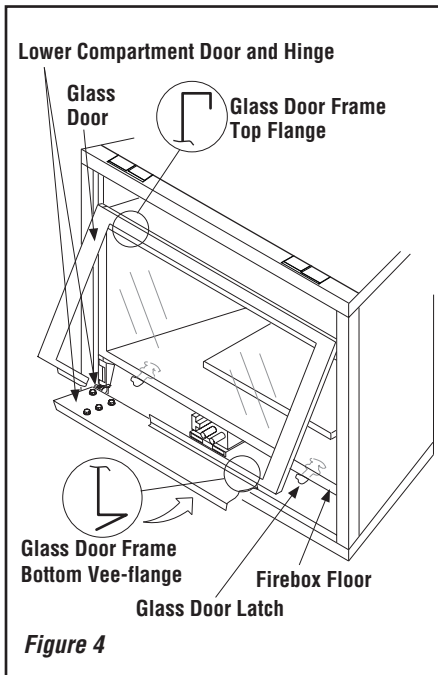

INSTALL VOLCANIC STONE, GLOWING EMBERS, AND LOGS

NOTE: Turn off all electricity to the appliance before you install volcanic stone, embers and logs.

! WARNING

- **DO NOT** attempt to install the logs until the appliance installation has been completed, the gas line connected, and tested for leaks and the initial burner operation has been checked out.
- The size and position of the log set was engineered to give the appliance a safe, reliable, and attractive flame pattern. Any attempt to use a different log set in the fireplace will void the warranty and will result in incomplete combustion, sooting, and poor flame quality.
- Logs get very hot and will remain hot up to one hour after gas supply is turned off. Handle only when logs are cool. Turn off all electricity to the appliance before you install grate, volcanic stone, embers and logs.
- This appliance is not designed to burn wood. Any attempt to do so could cause irreparable damage to the appliance and prove hazardous to your safety.
- If logs are not installed according to the log installation instructions, flame impingement and improper combustion could occur and result in soot and/or excessive production of carbon monoxide (CO), a colorless, odorless, toxic gas.

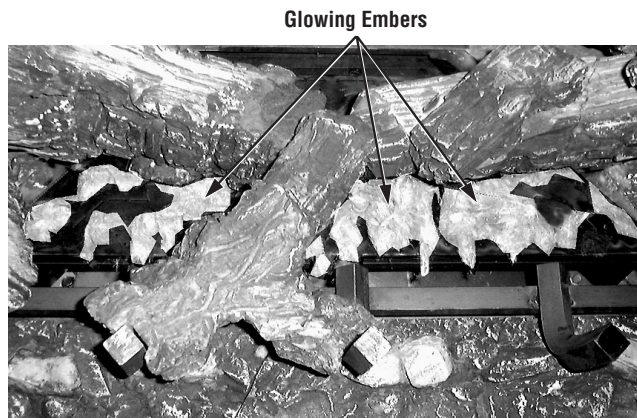

Figure 6

Step 1. Remove the appliance front door (see Removing Glass Enclosure panel on page 11.

Step 2. Install and volcanic stone—Sprinkle the volcanic stone in a pleasing pattern. The volcanic stone should be placed directly on top of the firebox bottom, along the front and to the back at the right and left sides of the burner. Position any optional ceramic fiber liners before placing the volcanic stone. Logs should be positioned after the volcanic stone.

Note: This appliance is provided with enough Glowing Embers for several applications, do not feel compelled to use all that is in a new bag. For best glowing effect, replace the ember material annually. Replacement Glowing Embers are available (Catalog Number 88L53).

Step 3. Separate the Glowing Ember (Rockwool) into pieces about the size of a

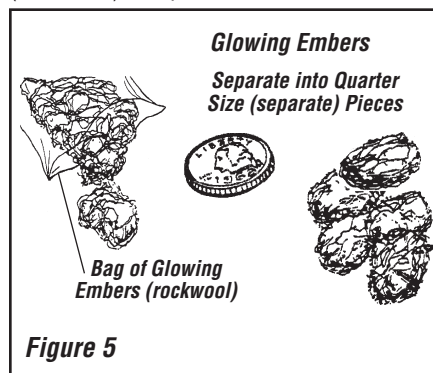

Figure 5

quarter (Figure 5). Keep the pieces fluffed up, not matted. Distribute these pieces over the front surface of the burner, as shown in Figure 6. Do not use more than is necessary. When properly positioned, the Glowing Embers will cover approximately 65% of the front burner and with no appreciable gaps or openings. Ensure that the main burner ports remain uncovered by the ember material. **Step 4. Placement of Logs**—All top logs that rest on lower logs,

do so over notches, indents or nubs. Proper log placement is critical to prevent sooting. Logs should be placed in the gaps between the flame peaks and should be positioned so they do not impinge the flames.

Step 5. Position the individual logs as shown in Figures 7, 8, and 9. Logs should be placed in the order shown. All logs that have notches to fit over the grate tines should be positioned with these notches directly against the grate. **Handle logs carefully to prevent breakage.**

Proper log placement is critical to encourage outstanding flame appearance and prevent sooting. When positioned properly as shown, logs will be positioned between flame peaks and will not impinge any flames.

Refer to Figure 7 for MPD33 series appliances, Figure 8 for MPD35 and MPD40 series appliances, and Figure 9 for MPD45 series appliances.

Firebox Accessories / Parts		
Cat. No.	Model No.	Description
88L53	FGE	Bag of Glowing Embers
80L42	FDVS	Bag of Decorative Volcanic Stone

NOTE: DIAGRAMS & ILLUSTRATIONS ARE NOT TO SCALE.

MPD33 LOG PLACEMENT

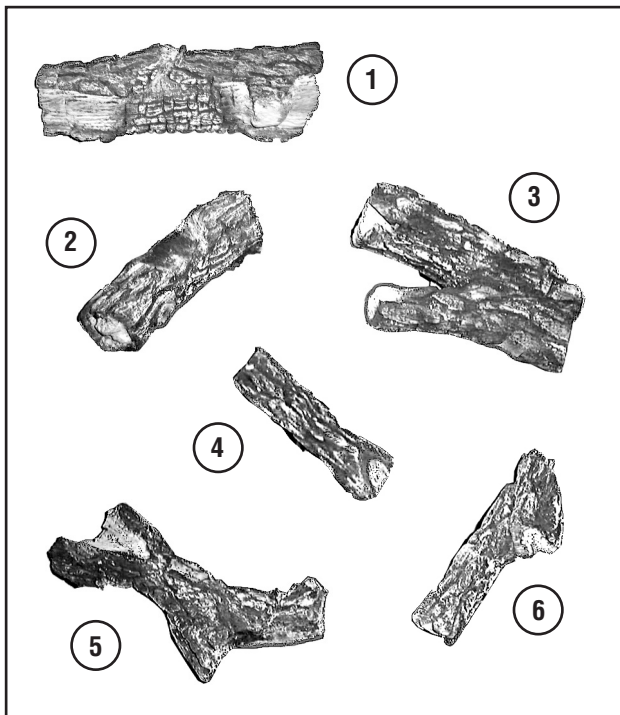

Log Number	Description (Stamped #)
1	Log, Rear (39-12)
2	Log, Left (39-1)
3	Log, Right (39-2)
4	Log, Top Center (39-13)
5	Log, Top/Left (39-3)
6	Log, Top/Right (39-4)

Catalog Number for the entire log set: 24M15

Position the individual logs as shown below. Logs should be placed in the order shown. Position the rear log on the brackets at the rear of the firebox with the log's notches directly over the brackets. Position the right log (log no. 3) by inserting the pin from the rear log into the hole on its upper end. Place the left log and then the smaller left and right top logs. All logs that have notches to fit over the grate tines should be positioned with these notches directly against the grate. All top logs that rest on lower logs, do so over flattened mounting faces in the bottom logs.

Proper log and twig placement is critical to encourage outstanding flame appearance and prevent sooting.

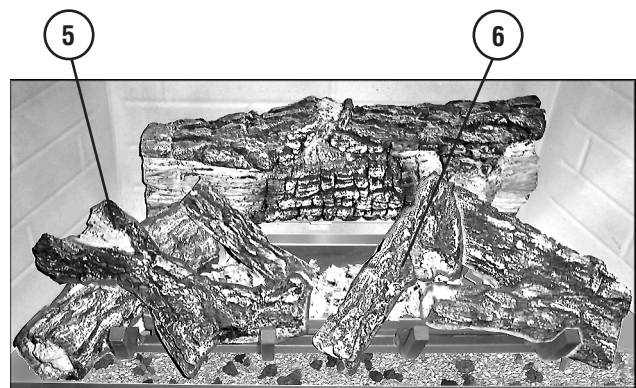
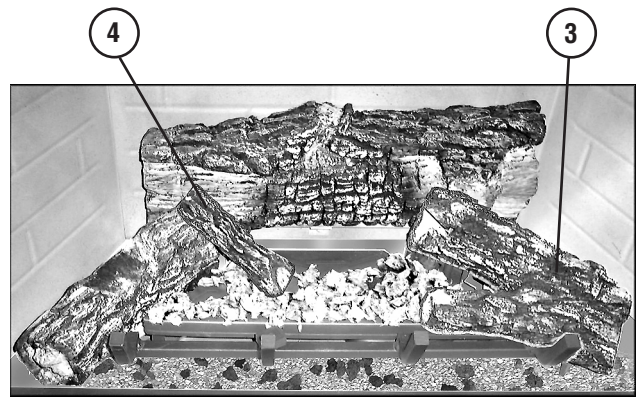
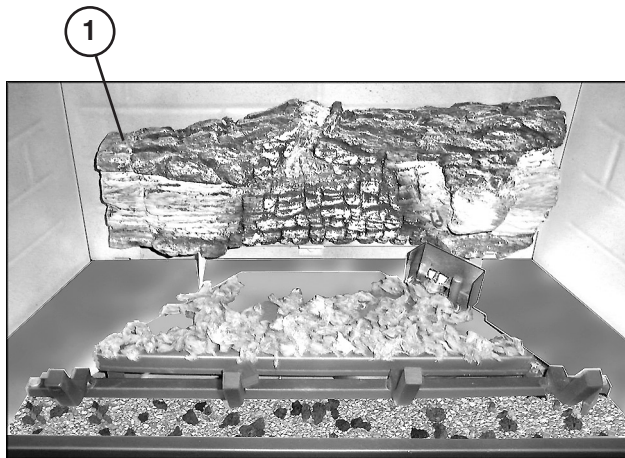
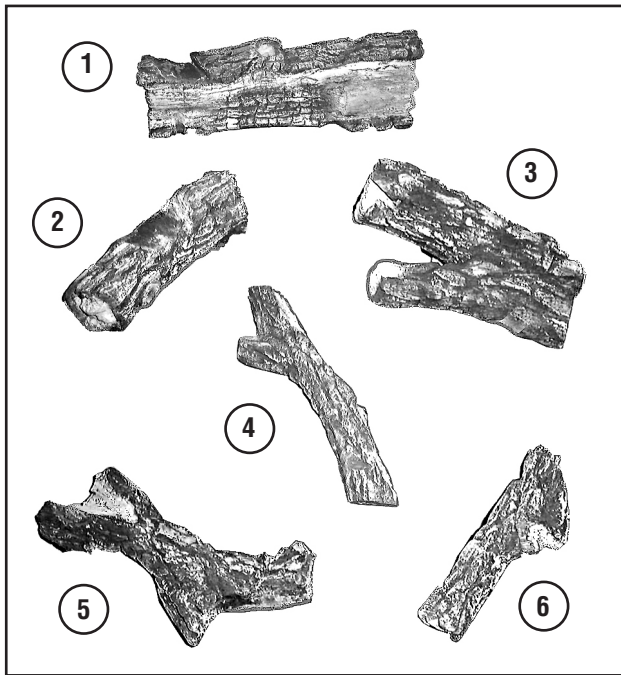

Figure 7

MPD35 LOG PLACEMENT



Log Number	Description (Stamped #)
1	Log, Rear (39-5)
2	Log, Left (39-1)
3	Log, Right (39-2)
4	Log, Top Center (39-6)
5	Log, Top/Left (39-3)
6	Log, Top/Right (39-4)

Catalog Number for the entire log set: H6197

Position the individual logs as shown below. Logs should be placed in the order shown. Position the rear log on the brackets at the rear of the firebox with the log's notches directly over the brackets. Position the right log (log no. 3) by inserting the pin from the rear log into the hole on its upper end. Place the left log and then the smaller left and right top logs. All logs that have notches to fit over the grate tines should be positioned with these notches directly against the grate. All top logs that rest on lower logs, do so over flattened mounting faces in the bottom logs.

Proper log and twig placement is critical to encourage outstanding flame appearance and prevent sooting.

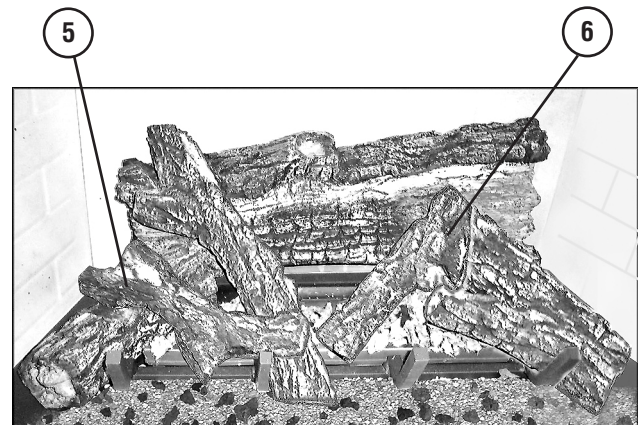
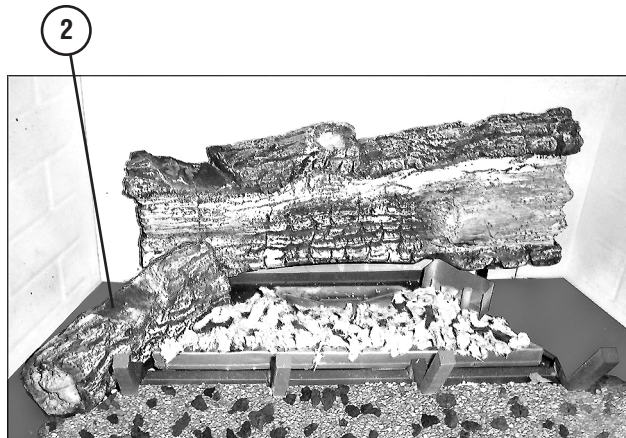
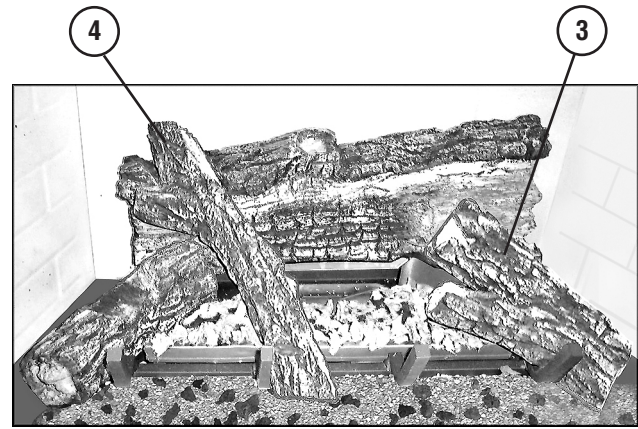
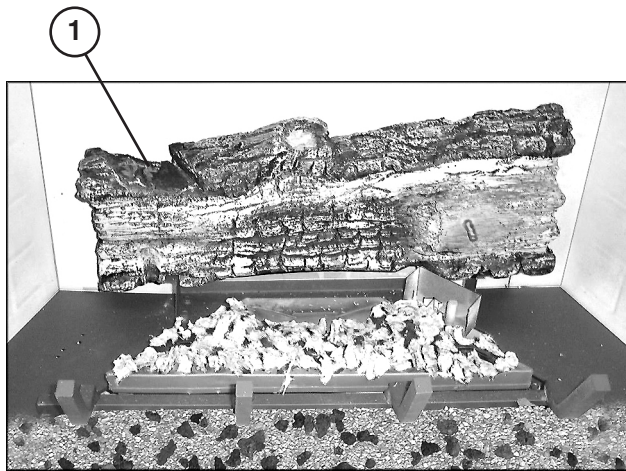
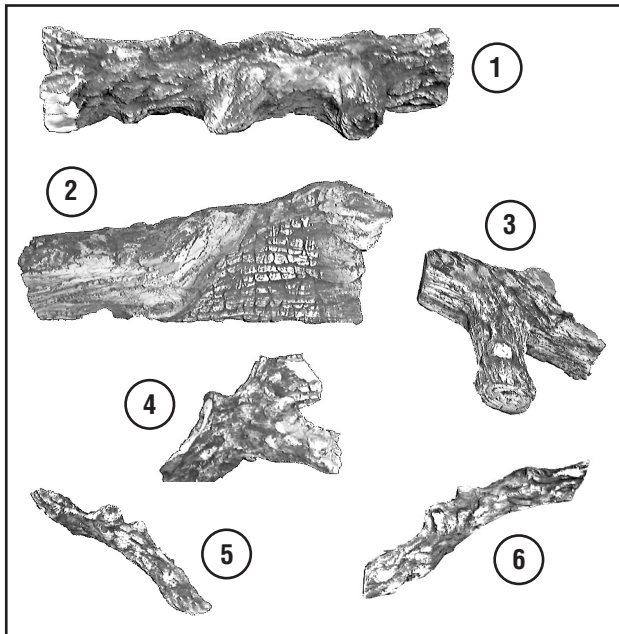

Figure 8

NOTE: DIAGRAMS & ILLUSTRATIONS ARE NOT TO SCALE.

MPD40 AND MPD45 LOG PLACEMENT



Log Number	Description (Stamped #)
1	Log, Center (39-8)
2	Log, Rear (138)
3	Log, Right (39-10)
4	Log, Left (39-9)
5	Log, Top/Left (39-11)
6	Log, Top/Right (39-11)

Catalog Number for the entire log set: 24M25

Position the individual logs as shown below. Logs should be placed in the order shown. Position the center log on the burner first, then place the glowing embers as shown in **Figure 6**. Place the rear log, both the right and left, and then the smaller left and right top logs. All logs that have notches to fit over the grate tines should be positioned with these notches directly against the grate. All top logs that rest on lower logs, do so over flattened mounting faces in the bottom logs.

Proper log and twig placement is critical to encourage outstanding flame appearance and prevent sooting.

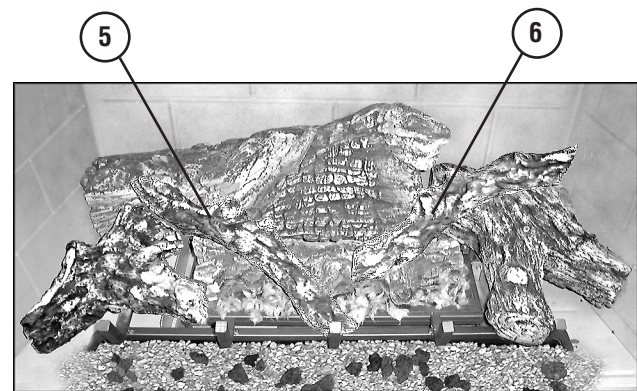
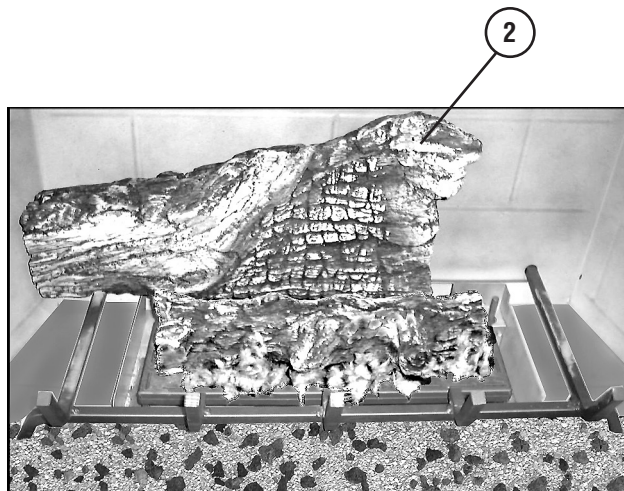
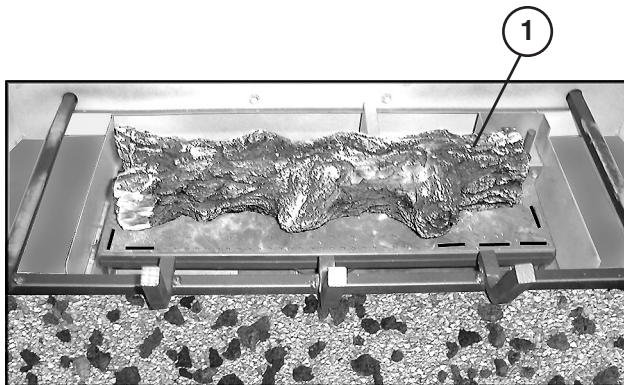

Figure 9

**BURNER ADJUSTMENTS
(QUALIFIED TECHNICIANS ONLY)**

Flame Appearance and Sooting

Proper flame appearance is a flame which is blue at the base and becomes yellowish-orange in the body of the flame.

When the appliance is first lit, the entire flame may be blue and will gradually turn yellowish-orange during the first 15 minutes of operation. If the flame remains blue, or if the flame is orange with evidence of sooting (black tip), the air shutter opening may need to be adjusted.

If the air shutter opening is closed too far, sooting may develop. Sooting is indicated by black puffs developing at the tips of very long orange flames. Sooting results in black deposits forming on the logs, appliance inside surfaces and on exterior surfaces adjacent to the vent termination.

Sooting is caused by incomplete combustion in the flames and lack of combustion air entering the air shutter opening. To achieve a warm yellowish-orange flame with an orange body that does not soot, the shutter opening must be adjusted between these two extremes.

Air Shutter Adjustment Guidelines

- If there is smoke or soot present, first check the log set positioning to ensure that the flames are not impinging on any of the logs. If the log set is properly positioned and a sooting condition still exists, then the air shutter opening should be increased.
- The more offsets in the vent system, the larger the air shutter opening will need to be.
- An appliance operated with the air shutter opened too far, may have flames that appear blue and transparent. These weak, blue and transparent flames are termed anemic.
- Propane models may exhibit flames which candle or appear stringy. If this is present and persists, adjust the air shutter to a more closed position, then operate the appliance for a few more minutes to ensure that the flame normalizes and the flames do not appear sooty.

The following chart is provided to aid you in achieving the correct air shutter adjustment for your installation.

Air Shutter Adjustment Guidelines:		
Amount of Primary Air	Flame Color	Air Shutter Adjustment
If air shutter is closed too far →	Flame will be orange →	Air shutter gap should be increased
If air shutter is open too far →	Flame will be blue →	Air shutter gap should be decreased

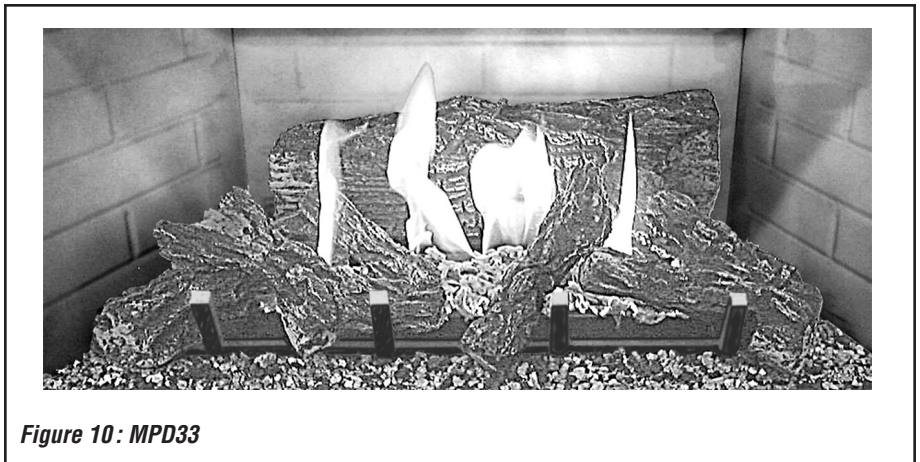

Figure 10: MPD33

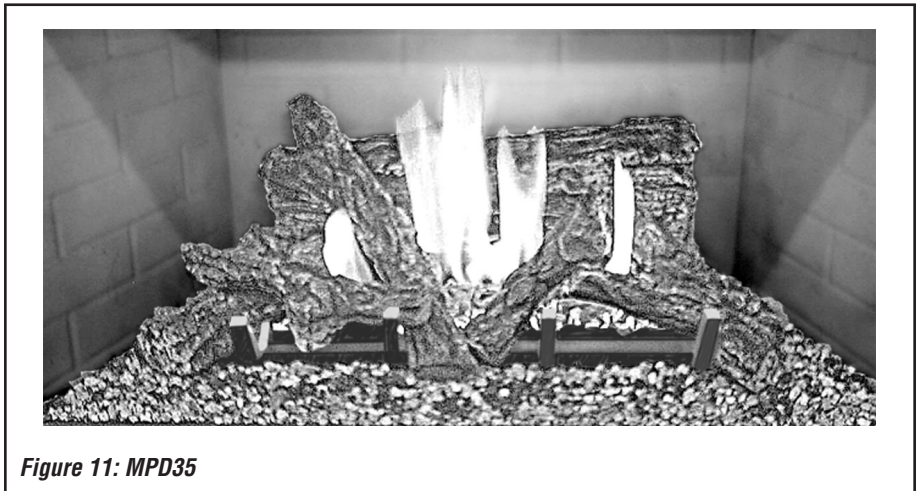

Figure 11: MPD35



Figure 12: MPD40 and MPD45

NOTE: DIAGRAMS & ILLUSTRATIONS ARE NOT TO SCALE.

! WARNING

- Air shutter adjustment should only be performed by a qualified professional service technician.
- Ensure front glass panel is in place and sealed during adjustment.

! CAUTION

- Soot will be produced if the air shutter is closed too much. Any damage due to sooting, resulting from improperly setting the air shutter, is not covered under the warranty.
- The air shutter door and nearby appliance surfaces are **HOT**. Exercise caution to avoid injury while adjusting flame appearance.

BURNER FLAME ADJUSTMENTS

1. Refer to **Figures 10, 11, and 12** for proper flame appearance. To adjust the flame, rotate the adjustment rod toward the back or toward the front of the fireplace (rod located in the lower control area). Position the air shutter to the factory setting as shown in the table in **Figure 13**.
2. Light appliance (follow lighting procedure on lighting label in control compartment or in this *Care and Operation Instructions*).
3. Allow the burner to operate for at least 15 minutes while observing the flame continuously to ensure that the proper flame appearance has been achieved. If the following conditions are present, adjust accordingly.
 - If flame appears weak or sooty, adjust the air shutter, incrementally, to a more open position until the proper flame appearance is achieved.
 - If flame remains blue, adjust the air shutter, incrementally, to a more closed position until the proper flame appearance is achieved.
4. When satisfied that the burner flame appearance is normal, turn the ON/OFF control (unit-mounted or remote switch, depending on your application) to the OFF position.
5. Reinstall the lower control access panel, then proceed to finish the installation.

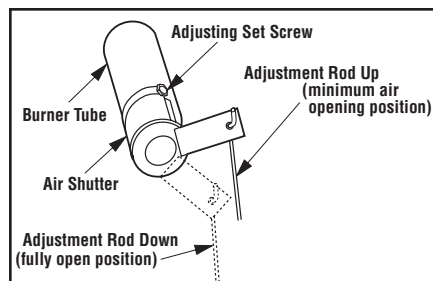

Models	Gas Type	FACTORY AIR SHUTTER SETTING inches (mm)
MPD33	Nat.	1/32 (0.8)
	Prop.	3/16 (4.76)
MPD35	Nat.	1/32 (0.8)
	Prop.	3/16 (4.76)
MPD40	Nat.	1/8 (3.2)
	Prop.	1/2 (13)
MPD45	Nat.	1/8 (3.2)
	Prop.	1/2 (13)

Figure 13

Millivolt Appliance Checkout

To light the burner, rotate the gas valve control knob counterclockwise to the ON position (“ON” will be at the top side of the valve).

The pilot flame should be steady, not lifting or floating. Flame should be blue in color with traces of orange at the outer edge.

The top 3/8 in. (10 mm) at the pilot generator (thermopile) and the top 1/8 in. minimum (tip) of the quick drop out thermocouple should be engulfed in the pilot flame.

The flame should project 1 in. (25 mm) beyond the hood at all three ports (see **Figure 14**). Replace logs if removed for pilot inspection.

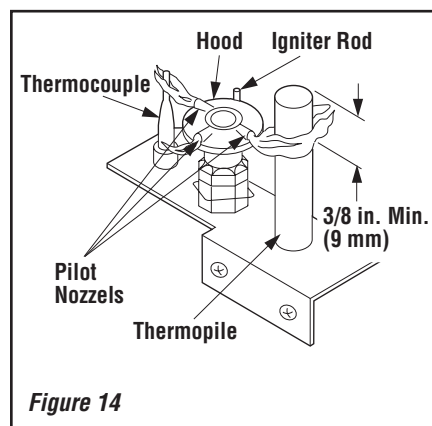

Figure 14

Electronic Appliance Checkout

Turn the ON/OFF control (unit-mounted or remote switch, depending on your application) to the ON position.

The pilot flame should engulf the flame rod, as shown in **Figure 15**.

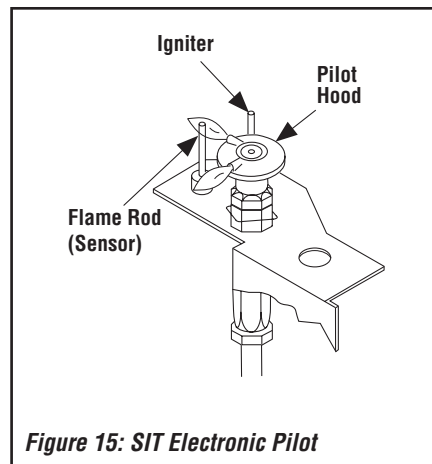
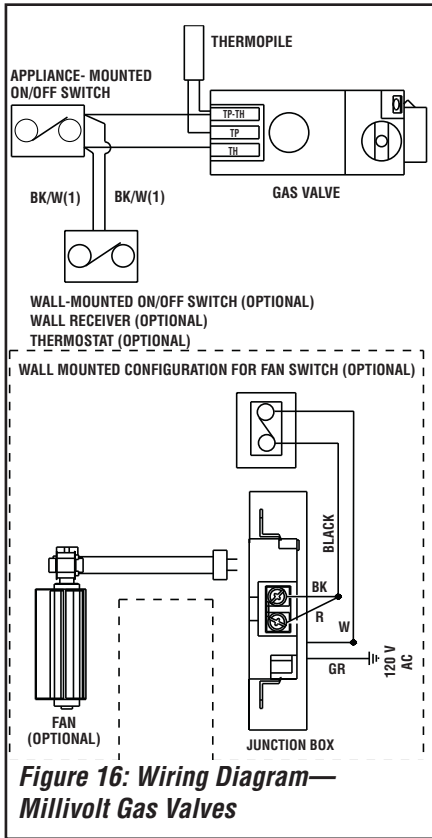

Figure 15: SIT Electronic Pilot

WIRING DIAGRAMS

Wiring diagrams are provided here for reference purposes only. This information is also provided on schematics attached directly to the appliance on a pullout panel located within the control compartment.



**Figure 16: Wiring Diagram—
Millivolt Gas Valves**

CAUTION: LABEL ALL WIRES PRIOR TO DISCONNECTION WHEN SERVICING CONTROLS. WIRING ERRORS CAN CAUSE IMPROPER AND DANGEROUS APPLIANCE OPERATION.

ORDERING REPLACEMENT PARTS

A complete parts list is found at the end of this manual. Use only parts supplied from the manufacturer.

With proper care and maintenance, your appliance will provide many years of enjoyment. If you should experience any problem, first refer to the troubleshooting guide in this manual. If problem persists, contact your Lennox Hearth Products dealer or distributor.

Normally, all parts should be ordered through your Lennox Hearth Products distributor or dealer.

Parts will be shipped at prevailing prices at time of order.

When ordering repair parts, always provide:

1. The model number of the appliance.
2. The serial number of the appliance.
3. The part number.
4. The description of the part.
5. The quantity required.
6. The installation date of the appliance.

If you encounter any problems or have any questions concerning the installation or application of this system, please contact your dealer or distributor.

LENNOX HEARTH PRODUCTS

**1508 Elm Hill Pike, Suite 108
Nashville, TN 37210**

visit us at www.LennoxHearthProducts.com
1-800-655-2008

PRODUCT REFERENCE INFORMATION

We recommend that you record the important reference information about your fireplace in the space provided below.

Please call Lennox Hearth Products for the phone number of your nearest Lennox Hearth Products dealer who will answer your questions or address your concerns.

Fireplace Model Number _____

Fireplace Serial Number _____

Date Installed _____

Type of Gas Used in Fireplace _____

Dealer Name _____

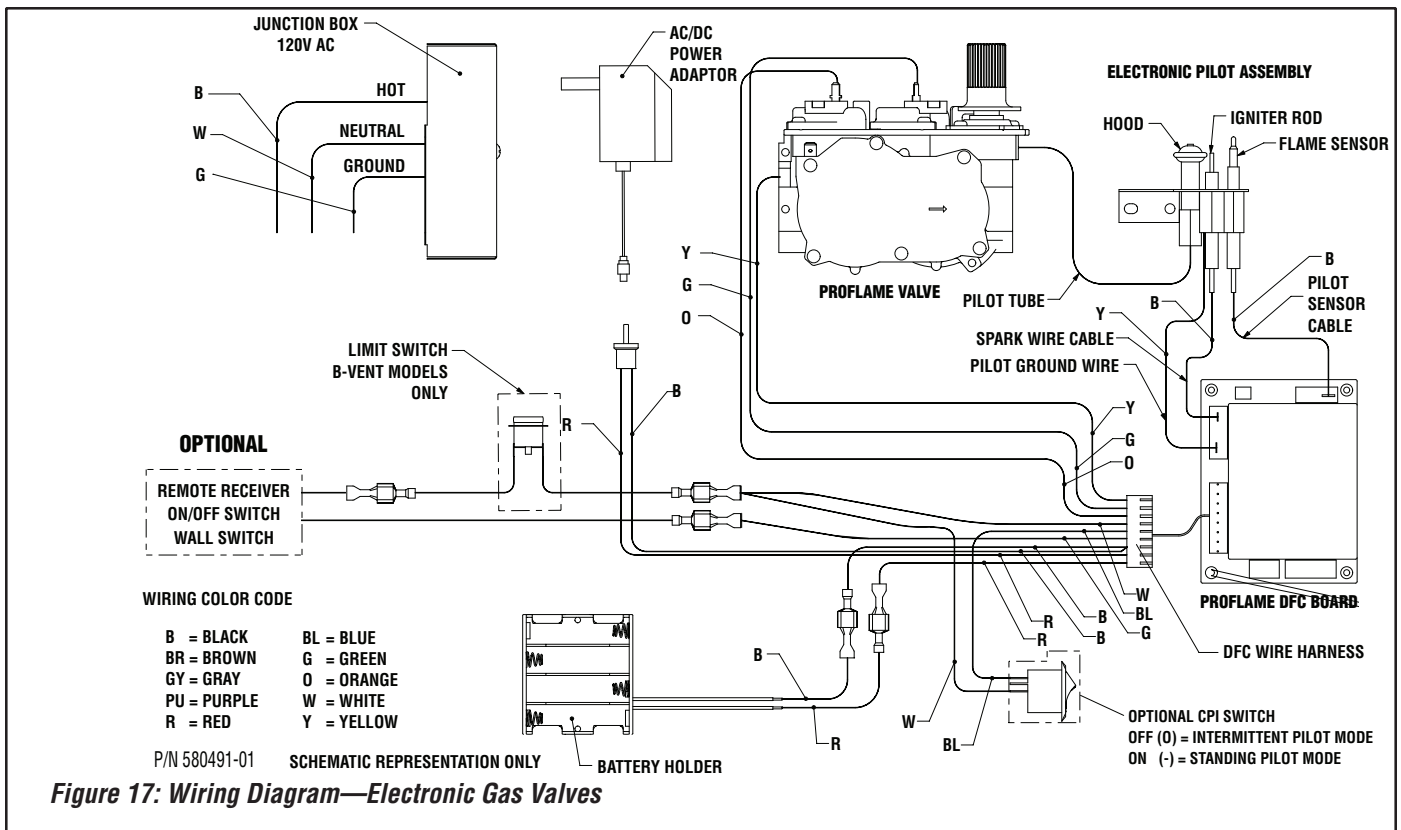

Figure 17: Wiring Diagram—Electronic Gas Valves

NOTE: DIAGRAMS & ILLUSTRATIONS ARE NOT TO SCALE.

ACCESSORY COMPONENTS



Economy G-Fire Remote Control System

Simple operation switches your fireplace on and off. The remote receiver may be wall-mounted (recommended for longer battery life) or placed in the control compartment.

G-Fire Remote Control System H8840



Digital Wall Thermostat

The wall thermostat kit provides temperature control for optimum comfort.

Wall Thermostat Kit, White H4635 DWTK



Touch-Up Paint Kit

Repair of minor scratches and discoloration of the appliance painted surfaces may be accomplished with the touch-up paint kit.

Touch-Up Paint (Black) Kit 90L73 TPK-B



Standard Remote Control System

The Model RCL (Standard) Remote Control System features a simple ON/OFF control function for the fireplace. Includes a hand-held transmitter, a remote receiver with wall-mount coverplate, and all required hardware to install the unit. The remote receiver can be wall- or hearth-mounted.

Remote Control System (Standard) H0249 RCL

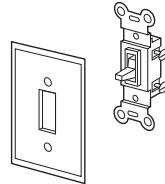

ON/OFF Wall Switch Kit

The ON/OFF wall switch may be used to control the operation of the fireplace burner as an alternative to the optional unit-mountable ON/OFF rocker switch. Install the wall switch in a convenient location near the fireplace.

ON/OFF Wall Switch Kit 85L87 FWSK

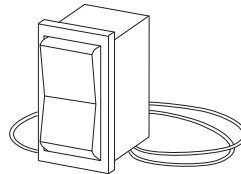

Unit-Mountable ON/OFF Rocker Switch Kit (Millivolt systems only)

The rocker switch may be used to provide ON/OFF operation as an alternative to the optional wall switch. The rocker switch installs directly in the gas valve mounting bracket (millivolt gas valve-equipped fireplaces only).

Rocker Switch Kit 80L41 FRS



Deluxe Remote Control System

The Model RCL-T (Deluxe) Remote Control System has all of the features of the standard system along with an added easy-to-read LCD screen that provides access to many enhancements, including battery power level indicator, timer, mode of operation, thermostatic display with room temperature in either F° or C°, flame indicator, and clock. Fully programmable, the Model RCL-T allows for command over nearly all operational and temperature variables using the hand-held remote control transmitter.

Remote Control System (Deluxe) H0251 RCL-STAT

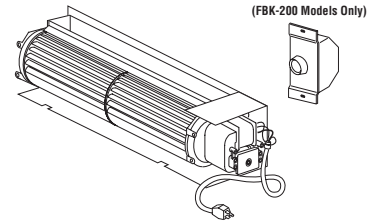

Forced Air Blower Kit

The FBK-100 blower assembly provides constant-velocity forced-air circulation.

The FBK-200 blower assembly provides variable-speed forced-air circulation and includes a wall-mountable variable-speed switch.

The FBK-250 blower assembly provides variable-speed forced-air circulation and includes a unit-mountable variable-speed switch.

Forced Air Blower Kits:

Single Speed	80L84	FBK-100
Variable Speed with wall-mountable switch	80L85	FBK-200
Variable Speed with unit-mountable switch	80L86	FBK-250

ACCESSORY COMPONENTS (continued)

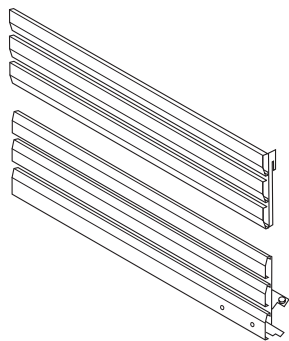

Assembled Louver Kits	
Model No.	Catalog No. Model No.
	Black Louvers
MPD33	24M45 LVR33C-2
MPD35	88L24 LVR35C-2
MPD40	88L25 LVR40C-2
MPD45	88L26 LVR45C-2

These louvers are designed to replace the standard radiant panels that are provided with the appliance.

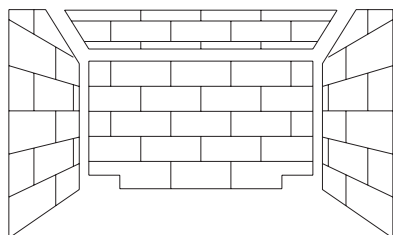

Firebox Liner Kits		
Models	Catalog No.	Model No.
MPDT33	H0912	MBLK33T
MPDR33	H8614	BLKC-MP33R
MPD35	H8595	BLKC-MP35
MPD40	H8596	BLKC-MP40
MPD45	H0915	MBLK45

The firebox liner kits include ceramic panels of the side walls, the rear and the baffle of the firebox. The panels have brick-like features in relief.

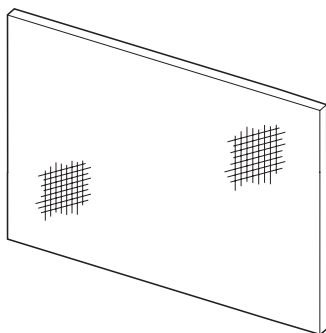

Screen Panel Kits	
Model No.	Catalog No. Model No.
MPD33	98L04 HG33
MPD35	26M48 HG35M
MPD40	26M49 HG40M
MPD45	26M50 HG45M

These screen panels can be installed on the glass enclosure panel to provided protection from the hot glass surface. The screen panel kits cannot be used in conjunction with either of the arch door kits or door frame kits.

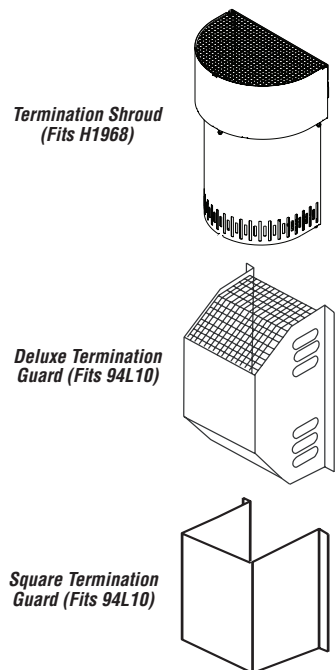

Termination Guard Kits

The vent termination guards may be used to cover the vent termination on the exterior of the home to minimize exposure to the hot surface of the termination.

Termination Guard Kits (all models)		
Cat. No.	Model No.	Description
H5820	4.5HTSK	Termination Shroud
87L02	SV4.5HGS	Termination Guard, Deluxe
17M52	SV4.5HGS-1	Termination Guard, Square

ACCESSORY COMPONENTS (continued)

Style View Doors

Style View doors come in three styles. They are easy to install onto the standard glass door frame. Includes heavy-duty magnetic door latches and functional twin-pane doors.

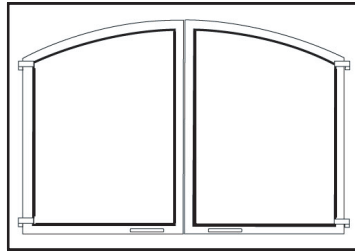

Arch Design

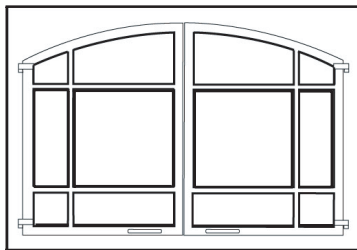

Arch Pane Design

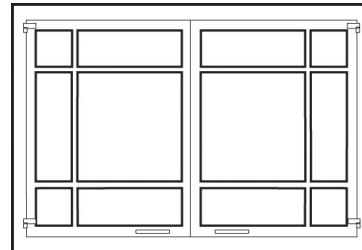

Square Pane Design

ARCH DESIGN KITS			
Cat. No.	Model	Description	Model Series
H8769	AD35B-2	35 in. Arch Doors, Black	MPD35
H8770	AD35SP-2	35 in. Arch Doors, Satin Pewter	
H8771	AD40B-2	40 in. Arch Doors, Black	MPD40
H8772	AD40SP-2	40 in. Arch Doors, Satin Pewter	
H8773	AD45B-2	45 in. Arch Doors, Black	MPD45
H8774	AD45SP-2	45 in. Arch Doors, Satin Pewter	
ARCH PANE DESIGN KITS			
H8775	APD35B-2	35 in. Arch Pane Doors, Black	MPD35
H8776	APD35SP-2	35 in. Arch Pane Doors, Satin Pewter	
H8777	APD40B-2	40 in. Arch Pane Doors, Black	MPD40
H8778	APD40SP-2	40 in. Arch Pane Doors, Satin Pewter	
H8779	APD45B-2	45 in. Arch Pane Doors, Black	MPD45
H8780	APD45SP-2	45 in. Arch Pane Doors, Satin Pewter	

SQUARE PANE DESIGN KITS			
Cat. No.	Model	Description	Model Series
H8781	SPB35B-2	35 in. Sq. Pane Doors, Black	MPD35
H8782	SPB35SP-2	35 in. Sq. Pane Doors, Satin Pewter	
H8783	SPB40B-2	40 in. Sq. Pane Doors, Black	MPD40
H8784	SPB40SP-2	40 in. Sq. Pane Doors, Satin Pewter	
H8785	SPB45B-2	45 in. Sq. Pane Doors, Black	MPD45
H8786	SPB45SP-2	45 in. Sq. Pane Doors, Satin Pewter	

ACCESSORY COMPONENTS (continued)

Grille Kits

The distinctive sunrise design grille is available in black or satin pewter finish. This grille may be used to replace the standard radiant panels or optional louvered panels. Upper and lower grilles are sold separately.

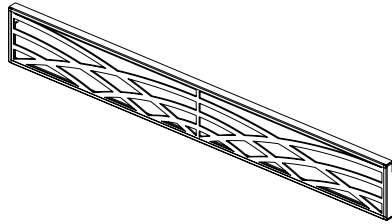

“Sunrise” Grille Kits			
Cat. No.	Model	Description	Model Series
H3565	SUGK35C	35 in. Sunrise Upper Grille Kit, Black	MPD35
H3567	SUGK35SP	35 in. Sunrise Upper Grille Kit, Satin Pewter	
H3569	SLGK35C	35 in. Sunrise Lower Grille Kit, Black	
H3571	SLGK35SP	35 in. Sunrise Lower Grille Kit, Satin Pewter	
H3573	SUGK40C	40 in. Sunrise Upper Grille Kit, Charcoal	MPD40
H3575	SUGK40SP	40 in. Sunrise Upper Grille Kit, Satin Pewter	
H3577	SLGK40C	40 in. Sunrise Lower Grille Kit, Black	
H3579	SLGK40SP	40 in. Sunrise Lower Grille Kit, Satin Pewter	
H3581	SUGK45C	45 in. Sunrise Upper Grille Kit, Black	MPD45
H3583	SUGK45SP	45 in. Sunrise Upper Grille Kit, Satin Pewter	
H3585	SLGK45C	45 in. Sunrise Lower Grille Kit, Black	
H3587	SLGK45SP	45 in. Sunrise Lower Grille Kit, Satin Pewter	

MAINTENANCE SCHEDULE

Annually (Before the onset of the Burning Season)

Maintenance Task	Accomplishing Person	Procedure
Inspect and Clean Burner, Logs and Controls	Qualified Service Technician	Inspect valve and ensure it is properly operating. Check piping for leaks. Vacuum the control compartment, fireplace logs and burner area.
Check Flame Patterns and Flame Height	Qualified Service Technician	Refer to Figures 10 (MPD33), 11 (MPD35) or 12 (MPD40 & MPD45) on page 16 and verify the flame pattern and height displayed by the appliance conforms to the picture. Flames must not impinge on the logs. Ensure flames are steady (not lifting or floating).
Inspect and Clean Pilot and Burner	Qualified Service Technician	Refer to Figure 13 (SIT) or Figure 14 (Honeywell) on page 17 . Remove any surface build-up on pilot and burner assembly. Wipe the pilot nozzles, igniter/flame rod and hood. Ensure the pilot flame engulfs the flame sensor as shown.
Check Vent System	Qualified Service Technician	Inspect the vent system at the top and at the base (within the firebox) for signs of blockage or obstruction. Look for any signs of dislocation of the vent components (reconnect or replace as necessary).
Appliance Checkout	Qualified Service Technician	Perform the appropriate appliance checkout procedure detailed in this manual.
Replace Glowing Embers	Homeowner/Qualified Services Technician	Remove old ember materials and vacuum the rockwool placement area. Place new rockwool as described in this document.

Periodically (After the Burning Season)

Maintenance Task	Accomplishing Person	Procedure
Clean Firebox Interior	Homeowner	Carefully remove logs, glowing embers and decorative volcanic stone. Vacuum out interior of the firebox. Clean firebox walls and log grate. Replace logs, glowing embers and volcanic stone as detailed in this manual.
Check Flame Patterns and Flame Height	Homeowner	Refer to Figures 10 (MPD33), 11 (MPD35) or 12 (MPD40 & MPD45) on Page 16 and verify the flame pattern and height displayed by the appliance conforms to the picture. Flames must not impinge on the logs.
Check Vent System	Homeowner	Inspect the vent system at the top and at the base (within the firebox) for signs of blockage or obstruction. Look for any signs of dislocation of the vent components (reconnect or replace as necessary).
Clean Front Glass Enclosure Panel	Homeowner	Clean as necessary following the directions provided in this manual. DO NOT TOUCH OR ATTEMPT TO CLEAN GLASS WHILE HOT.

LIGHTING INSTRUCTIONS – MILLIVOLT GAS VALVE

FOR YOUR SAFETY, READ BEFORE LIGHTING

WARNING: If you do not follow these instructions exactly, a fire or explosion may result, causing property damage, personal injury, or loss of life.

A. This appliance has a pilot which must be lighted by a piezo igniter. When lighting the pilot, follow these instructions exactly.

B. BEFORE LIGHTING smell all around the appliance area for gas. Be sure to smell next to the floor because some gas is heavier than air and will settle on the floor.

WHAT TO DO IF YOU SMELL GAS:



- Do not try to light any appliance.
- Do not touch any electric switch; do not use any phone in your building.

- Immediately call your gas supplier from a neighbor's phone. Follow the gas supplier's instructions.
- If you cannot reach your gas supplier, call the fire department.

C. Use only your hand to push in or turn the gas control knob. Never use tools. If the knob will not push in or turn by hand, don't try to repair it, call a qualified service technician. Force or attempted repair may result in a fire or explosion.

D. Do not use this appliance if any part has been under water. Immediately call a qualified service technician to inspect the appliance and to replace any part of the control system and any gas control which has been under water.

LIGHTING INSTRUCTIONS

1. STOP! Read the safety information above on this label.
2. (If applicable) Set the thermostat to lowest setting. Turn wall on/off switch, unit mounted on/off switch or remote control switch "OFF."
3. Turn OFF all electric power to the appliance.
4. Access the control compartment.
5. Push in gas control knob slightly and turn clockwise  to "OFF."
NOTE: Knob cannot be turned from "PILOT" to "OFF" unless knob is pushed in slightly. Do Not force.
6. Wait five (5) minutes to clear out any gas. Then smell for gas, including near the floor. If you smell gas, STOP! Follow "B" in the safety information above on this label. If you don't smell gas, go to the next step.
7. Find pilot—located in firebox on the same plane as the top of the burner.
8. Turn knob on gas control counterclockwise  to "PILOT."
9. Push in control knob all the way and hold in. Immediately light the pilot by triggering the piezo igniter (pushing the button) until pilot lights. Continue to hold the control knob in for about 1-1/2 minutes after the pilot is lit. Release knob and it will pop back up. Pilot should remain lit. If it goes out, repeat steps 5 through 9.
 - If knob does not pop up when released, stop and immediately call your service technician or gas supplier.

- If the pilot will not stay lit after several tries, turn the gas control knob to "OFF" and call your service technician or gas supplier.
10. Turn gas control knob counterclockwise  to "ON."
 11. Close control compartment.
 12. (If applicable) Turn on all electrical power to the appliance.
 13. (If applicable) Set thermostat to desired setting. Turn wall on/off switch, unit mounted on/off switch or remote control switch "ON."

Gas Control Valves

Pilot Assemblies

SIT

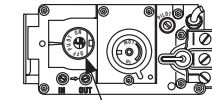

Gas Control Knobs

Robertshaw

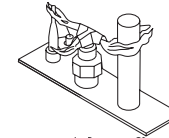
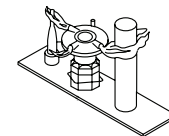
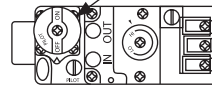

TO TURN OFF GAS TO APPLIANCE

1. (If applicable) Set the thermostat to lowest setting. Turn wall on/off switch, unit mounted on/off switch or remote control switch "OFF."
2. Turn OFF all electric power to the appliance, if service is to be performed.
3. Access the control compartment.
4. Push in gas control knob slightly and turn clockwise  to "OFF." Do not force.
5. Close the main line gas shut-off valve.
6. Close control compartment.



WARNING



**HOT GLASS WILL CAUSE BURNS.
DO NOT TOUCH GLASS UNTIL COOLED.
NEVER ALLOW CHILDREN TO TOUCH GLASS.**

INSTRUCTIONS D'ALLUMAGE – VANNE GAZ MILLIVOLT

POUR PLUS DE SÉCURITÉ, LIRE AVANT D'ALLUMER

AVERTISSEMENT. Quiconque ne respecte pas à la lettre les instructions dans la présente notice risque de déclencher un incendie ou une explosion entraînant des dommages, des blessures ou la mort.

A. Cet appareil est muni d'une veilleuse qui doit être allumée avec un allumeur piézo-électrique. Respectez les instructions ci-dessous à la lettre.

B. **AVANT L'ALLUMAGE:** Avant d'allumer la veilleuse, reniflez tout autour de l'appareil pour déceler une odeur de gaz. Reniflez près du plancher, car certains gaz sont plus lourds que l'air et peuvent s'accumuler au niveau du sol.

QUE FAIRE SI VOUS SENTEZ UNE ODEUR DE GAZ :

- Ne pas tenter d'allumer d'appareil.
- Ne touchez à aucun interrupteur ; ne pas vous servir des téléphones se trouvant dans le bâtiment.

- Appelez immédiatement votre fournisseur de gaz depuis un voisin. Suivez les instructions du fournisseur.
- Si vous ne pouvez rejoindre le fournisseur, appelez le service des incendies.

C. Ne pousser ou tourner la manette d'admission du gaz qu'à la main. Ne jamais employer d'outil à cette fin. Si la manette reste coincée, ne tentez pas de la réparer; appelez un technicien qualifié. Quiconque tente de forcer la manette ou de la réparer peut provoquer une explosion ou un incendie.

D. N'utilisez pas cet appareil s'il a été plongé dans l'eau, même partiellement. Faites inspecter l'appareil par un technicien qualifié et remplacez toute partie du système de contrôle et toute commande qui ont été plongés dans l'eau.

INSTRUCTIONS D'ALLUMAGE

1. **ARRÊTEZ !** Lisez les instructions de sécurité sur la portion supérieure de cette étiquette.
2. (Si applicable) Réglez le thermostat à la température la plus basse. Tournez l'interrupteur murale, l'interrupteur sur l'unité ou le contrôle à distance à "OFF."
3. Coupez l'alimentation électrique de l'appareil.
4. Accédez au compartiment de contrôle.
5. Enfoncez légèrement le bouton de réglage du gaz et tournez-le dans le sens des aiguilles d'une montre jusqu'à la position d'arrêt "OFF".
Remarque: Il est impossible de tourner le bouton de "PILOT" à "OFF" à moins qu'il ne soit légèrement enfoncé. Ne le forcez pas.
6. Attendez cinq (5) minutes pour laisser échapper tout le gaz. Reniflez tout autour de l'appareil, y compris près du plancher, pour déceler une odeur de gaz. Si vous sentez une odeur de gaz, **ARRÊTEZ !** Passez à l'étape B des instructions de sécurité sur la portion supérieure de cette étiquette. S'il n'y a pas d'odeur de gaz, passez à l'étape suivante.
7. Trouver le pilote – Situé dans l'âtre sur la même surface que le dessus du brûleur.
8. Tournez le bouton de contrôle sur la valve à gaz dans le sens antihoraire vers "Pilote".
9. Enfoncez le bouton de réglage jusqu'au fond et gardez-le enfoncé. Allumez immédiatement la veilleuse en déclenchant l'allume-gaz à étincelle (en poussant le bouton) jusqu'à ce que la veilleuse s'enflamme. Continuez de tenir le bouton de réglage enfoncé pendant environ 90 secondes après l'allumage de la veilleuse. Relâchez le bouton et il sortira subitement. La veilleuse devrait rester allumée. Si elle s'éteint, répétez les étapes 5 à 8 inclusivement.

- Si la manette ne se soulève pas d'elle-même lorsqu'on la relâche, arrêter et appeler immédiatement un technicien qualifié ou le fournisseur de gaz.
 - Si la veilleuse ne reste pas allumée après plusieurs tentatives, réglez la manette d'admission du gaz à la position OFF et appelez un technicien qualifié ou le fournisseur de gaz.
10. Tournez le bouton de réglage du gaz en sens inverse des aiguilles d'une montre jusqu'à sa position de marche "ON".
 11. Fermer le compartiment de contrôle.
 12. (Si applicable) Mettez l'appareil sous tension.
 13. (Si applicable) Réglez le thermostat à la température désirée. Tournez l'interrupteur murale, l'interrupteur sur l'unité ou le contrôle à distance à "ON."

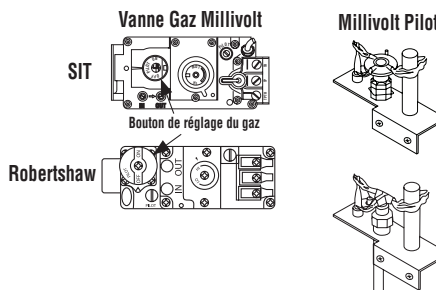

COMMENT COUPER L'ADMISSION DE GAZ DE L'APPAREIL

1. (Si applicable) Réglez le thermostat à la température la plus basse. Tournez l'interrupteur murale, l'interrupteur sur l'unité ou le contrôle à distance à "OFF."
2. Coupez l'alimentation électrique de l'appareil s'il faut procéder à l'entretien.
3. Accédez au compartiment de contrôle.
4. Enfoncez légèrement le bouton de réglage du gaz et tournez-le dans le sens des aiguilles d'une montre jusqu'à la position d'arrêt "OFF". Ne forcez pas le bouton.
5. Fermer la valve de gaz principale.
6. Fermer le compartiment de contrôle.



AVERTISSEMENT



**UNE SURFACE VITRÉE CHAUDE PEUT CAUSER DES BRÛLURES.
LAISSER REFROIDIR LA SURFACE VITRÉE AVANT D'Y TOUCHER.
NE PERMETTEZ JAMAIS À UN ENFANT DE TOUCHER LA SURFACE VITRÉE.**

LIGHTING INSTRUCTIONS—ELECTRONIC

FOR YOUR SAFETY, READ BEFORE OPERATING

WARNING: If you do not follow these instructions exactly, a fire or explosion may result, causing property damage, personal injury, or loss of life.

- A. This appliance is equipped with an ignition device which automatically lights the pilot. Do not try to light the pilot by hand.
- B. **BEFORE OPERATING** smell all around the appliance area for gas. Be sure to smell next to the floor because some gas is heavier than air and will settle on the floor.

WHAT TO DO IF YOU SMELL GAS:

- Do not try to light any appliance.
- Do not touch any electric switch; do not use any phone in your building.

- Immediately call your gas supplier from a neighbor's phone. Follow the gas supplier's instructions.
 - If you cannot reach your gas supplier, call the fire department.
- C. If any portion of this appliance does not operate as the instructions indicate, do not try to repair it, call a qualified service technician. Do not use tools. Force or attempted repair may result in a fire or explosion.
- D. Do not use this appliance if any part has been under water. Immediately call a qualified service technician to inspect the appliance and to replace any part of the control system and any gas control which has been under water.

OPERATING INSTRUCTIONS

1. **STOP!** Read the safety information above on this label.
2. Read the Care and Operation manual including the section on "Remote Control System," (if applicable).
3. Slide the switch on the receiver, wall switch or ON/OFF switch to "OFF."
4. Turn "OFF" all electric power to the appliance.
Note: The control may have a battery backup (remove batteries, if installed).
5. This appliance is equipped with an ignition device which automatically lights the pilot. Do not try to light the pilot by hand.
6. Wait five (5) minutes to clear out any gas. If you then smell gas, **STOP!** Follow "B" in the safety information above on this page. If you do not smell gas, go to the next step.
7. Turn on all electric power to the appliance. Note: The control may have a battery backup (install batteries, if applicable).
8. Slide the switch on the receiver to REMOTE or ON/OFF switch / wall switch to ON.
9. (if applicable) Press ON/OFF button on remote control transmitter to "ON."
10. (if applicable) Set thermostat on remote control to desired setting.
11. If the appliance will not operate, follow the instructions "To Turn Off Gas To Appliance" and call your service technician or gas supplier.

Electronic Gas Control Valve—SIT

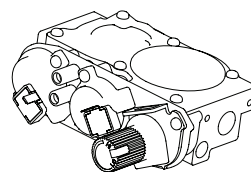

Electronic Pilot Assembly

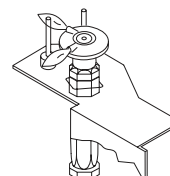

TO TURN OFF GAS TO APPLIANCE

1. Slide the switch on the receiver, wall switch or ON/OFF switch to "OFF."
2. (if applicable) Press ON/OFF button on remote control transmitter to "OFF."
3. Turn off all electric power to the appliance if service is to be performed. Note: The control may have a battery backup (remove batteries, if installed).
4. Close the main line gas shut-off valve.



WARNING



**HOT GLASS WILL CAUSE BURNS.
DO NOT TOUCH GLASS UNTIL COOLED.
NEVER ALLOW CHILDREN TO TOUCH GLASS.**

INSTRUCTIONS D'ALLUMAGE—ELECTRONIC

POUR PLUS DE SÉCURITÉ, LIRE AVANT DE METTRE EN MARCHÉ

AVERTISSEMENT. Quiconque ne respecte pas à la lettre les instructions dans la présente notice risque de déclencher un incendie ou une explosion entraînant des dommages, des blessures ou la mort.

- A. Cet appareil est muni d'un dispositif d'allumage qui allume automatiquement la veilleuse. Ne tentez pas d'allumer la veilleuse manuellement.
- B. **AVANT DE FAIRE FONCTIONNER**, reniflez tout autour de l'appareil pour détecter une odeur de gaz. Reniflez près du plancher, car certains gaz sont plus lourds que l'air et peuvent s'accumuler au niveau du sol.
- QUE FAIRE SI VOUS SENTEZ UNE ODEUR DE GAZ :**
- Ne pas tenter d'allumer d'appareil.
 - Ne touchez à aucun interrupteur; ne pas vous servir des téléphones se trouvant dans le bâtiment.
 - Appelez immédiatement votre fournisseur de gaz depuis un voisin. Suivez les instructions du fournisseur.
- Si vous ne pouvez rejoindre le fournisseur, appelez le service des incendies.
- C. Si un élément de cette unité ne fonctionne pas tel que décrit dans les instructions, n'essayez pas de le réparer, appelez un technicien qualifié. N'utilisez pas d'outils. Le fait de forcer la manette ou de la réparer peut déclencher une explosion ou un incendie.
- D. N'utilisez pas cet appareil s'il a été plongé dans l'eau, même partiellement. Faites inspecter l'appareil par un technicien qualifié et remplacez toute partie du système de contrôle et toute commande qui ont été plongés dans l'eau.

INSTRUCTIONS DE MISE EN MARCHÉ

1. **ARRÊTEZ !** Lisez les avertissements de sécurité à l'endos de cette étiquette.
2. Lisez le manuel d'utilisation et d'entretien incluant la section « Système de télécommande » (si applicable).
3. Placez l'interrupteur mural ou "on/off" en position "off."
4. Coupez l'alimentation électrique de l'appareil. Note: Le contrôleur peut avoir une batterie de secours (retirer les batteries au besoin).
5. Cet appareil est muni d'un dispositif d'allumage qui allume automatiquement la veilleuse. Ne tentez pas d'allumer la veilleuse manuellement.
6. Attendez cinq (5) minutes** pour laisser échapper tout le gaz. Reniflez tout autour de l'appareil, y compris près du plancher, pour détecter une odeur de gaz. Si vous sentez une odeur de gaz, **ARRÊTEZ !** Passez à l'étape B des instructions de sécurité sur la portion supérieure (à gauche) de cette étiquette. S'il n'y a pas d'odeur de gaz, passez à l'étape suivante.
7. Mettez l'appareil sous tension. Note: Le contrôleur peut avoir une batterie de secours (installer les batteries au besoin).
8. Placez l'interrupteur du récepteur en position "REMOTE" (ou l'interrupteur mural en position ON).
9. (Si applicable) Appuyez sur le bouton "ON/OFF" pour sélectionner "ON".
10. (Si applicable) Ajustez le thermostat sur la télécommande à l'ajustement désiré.
11. Si l'appareil ne se met pas en marche, suivez les instructions intitulées « Comment couper l'admission de gaz de l'appareil » et appelez un technicien qualifié ou le fournisseur de gaz.

Valve électronique—SIT

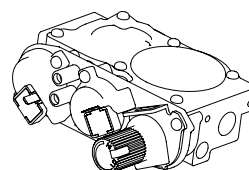

Module de veilleuse électronique

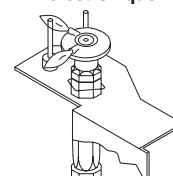

COMMENT COUPER L'ADMISSION DE GAZ DE L'APPAREIL

1. Placez l'interrupteur mural ou "on/off" en position "off."
2. (Si applicable) Sélectionnez OFF sur le récepteur.
3. Coupez l'alimentation électrique de l'appareil s'il faut procéder à l'entretien. Note: Le contrôleur peut avoir une batterie de secours (retirer les batteries au besoin).
4. Fermer la valve de gaz principale.



AVERTISSEMENT



**UNE SURFACE VITRÉE CHAUDE PEUT CAUSER DES BRÛLURES.
LAISSER REFROIDIR LA SURFACE VITRÉE AVANT D'Y TOUCHER.
NE PERMETTEZ JAMAIS À UN ENFANT DE TOUCHER LA SURFACE VITRÉE.**

TROUBLESHOOTING GUIDE: MILLIVOLT GAS CONTROL SYSTEM

Note: Before troubleshooting the gas control system, make sure the external gas shut off valve (located at gas supply inlet) is in the “ON” position.

Note: Valve system troubleshooting should only be performed by a qualified service technician.

SYMPTOM	POSSIBLE CAUSES	CORRECTIVE ACTION
<p>1. Spark igniter will not light pilot after repeated triggering of igniter button.</p>	<p>A. Defective igniter (no spark at electrode).</p>	<p>Check for spark at electrode and pilot; if no spark and electrode wire is properly connected, replace igniter.</p>
	<p>B. Defective or misaligned electrode at pilot (spark at electrode).</p>	<p>Using a match, light pilot. If pilot lights, turn off pilot and trigger the igniter button again. If pilot lights, an improper gas mixture caused the bad lighting and a longer purge period is recommended. If pilot will not light – check gap at electrode and pilot – should be 1/8 in. to have a strong spark. If gap measures 1/8 in., replace pilot (Figure 14 on page 17).</p>
	<p>C. Gas supply pressure errant.</p>	<p>Check inlet gas pressure. It should be within the limits as marked on the rating plate.</p>
	<p>D. Pilot orifice plugged.</p>	<p>Clean or replace pilot orifice.</p>
<p>2. Pilot will not stay lit after carefully following the lighting instructions.</p>	<p>A. Defective pilot generator (thermocouple).</p>	<p>Check pilot flame, it must impinge on thermocouple (Figure 14 on page 17). Clean and/or adjust pilot for maximum flame impingement on thermocouple. Ensure that the connection between the valve and thermocouple are tight and secure.</p>
<p>3. Pilot burning, no gas to burner, Valve knob “ON,” Wall Switch “ON.”</p>	<p>A. Wall switch or wires defective.</p>	<p>Check wall switch and wires for proper connections. Jumper wire across terminals at wall switch, if burner comes on, replace defective wall switch. If okay, jumper wires across wall switch wires at valve, if burner comes on, wires are faulty or connections are bad.</p>
	<p>B. Thermopile may not be generating sufficient millivoltage.</p>	<p>Check thermopile with millivolt meter. Take reading at thermopile terminals of gas valve. Should read 325 millivolts minimum with optional wall switch “OFF.” Replace faulty thermopile if reading is below specified minimum.</p>
	<p>C. Plugged burner orifice.</p>	<p>Check burner orifice for stoppage and remove.</p>
<p>4. Frequent pilot/burner outage problem.</p>	<p>A. Pilot flame may be too low or blowing (high) causing the pilot/valve safety to drop out.</p>	<p>Clean and/or adjust pilot flame for maximum flame impingement on thermocouple (Figure 14 on page 17).</p>

TROUBLESHOOTING GUIDE: ELECTRONIC GAS CONTROL SYSTEM

Note: Before troubleshooting the gas control system, make sure the external gas shut off valve (located at gas supply inlet) is in the “ON” position.

Note: Valve system troubleshooting should only be performed by a qualified service technician.

SYMPTOM	POSSIBLE CAUSES	CORRECTIVE ACTION
1. Nothing happens when the fireplace is turned ON/OFF.	A. Remote control system is not functioning properly.	To use the remote control system, the wall switch plate must be set to REMOTE.
		Manually operate the fireplace using the wall switch (ON/OFF).
		Replace the batteries in the handheld remote and/or behind the wall switchplate.
	B. Unit is not receiving power.	Check/replace batteries behind the wall switchplate.
		Replace unit battery backup.
		Check building circuit breakers to ensure power is on to the fireplace.
C. Gas is not reaching the fireplace.	Check the gas supply and gas shutoff valves (call a service technician, if required).*	
2. The main burner does not light and the igniter is sparking.	A. Gas is not reaching the fireplace.	Check the gas supply and gas shutoff valves (call a service technician, if required).*
	B. Unit is not receiving power.	Replace unit battery backup.
	C. Loose wires to the valve.	Check control compartment for any obvious loose wiring (call a service technician).
	D. Loose wires to ignition module.	Check control compartment for any obvious loose wiring (call a service technician).
	E. Air in the gas line.	Purge gas line of air (call a service technician).
3. The burner lights, then immediately goes out.	A. Gas is not reaching the fireplace.	Check the gas supply and gas shutoff valves (call a service technician, if required).*
	B. Loose wires to the valve or ignition module.	Check the gas supply and gas shutoff valves (call a service technician, if required).*
	C. Pilot flame is not engulfing the sensor.	Call a service technician.
	D. Obstructed vent system.	Call a service technician.
4. Soot is present on the glass and panels.	A. Initial fireplace operation.	A white film may develop on the glass during the first few fires as part of the burn-in process. The first few times you use the fireplace, clean the glass after each use (AFTER THE GLASS HAS COMPLETELY COOLED); otherwise, the white film will bake onto the glass and become difficult to remove. See glass cleaning instructions in the MAINTENANCE section of this manual.
	B. Excessive flame impingement on panels and fireplace ceiling.	Properly position the media as detailed in the instructions provided with the Media Kit.
	C. Improper air shutter opening.	Open the air shutter by adjusting the air shutter adjustment lever according to the instructions in this manual.
	D. Improper vent restrictor setting.	Open the air shutter by adjusting the air shutter adjustment lever according to the instructions in this manual.
5. Poor flame and/or blue flame.	Door seal is not properly aligned, causing gaps and air leaks.	Remove and realign the door so the gasket seal is fully engaged around the door frame.

*The unit may have multiple gas supply shutoffs (the main gas supply valve in the house, the gas supply valve in the fireplace control compartment, and/or an additional shutoff valve near the fireplace).

REPLACEMENT PARTS LIST

Item No.	Description	MPD33		MPD35		MPD40		MPD45	
		Part No.	Qty.	Part No.	Qty.	Part No.	Qty.	Part No.	Qty.
1	Hood	H4574	1	97K51	1	97K52	1	97K53	1
2	Radiant Panel Assembly, Upper	H8660	1	H8661	1	H8662	1	H8663	1
2a	Louvered Panel Assembly, Upper	H4577	1	H6337	1	H2727	1	H3146	1
3	Radiant Panel Assembly, Lower	H8664*	1	H8665*	1	H8666*	1	H8667*	1
3a	Louvered Panel Assembly, Lower	H4578*	1	H6344*	1	H6345*	1	H6346*	1
4	Enclosure, Glass Front (Complete)	H8142	1	H6554	1	H8122	1	H6225	1
5	Nameplate (Brand)	12L15	1	12L15	1	12L15	1	12L15	1
6	Door Latch Spring	H1264	2	H1264	2	H1264	2	H1264	2
7	Catch, Door, Magnetic	69L31	2	69L31	2	69L31	2	69L31	2
8	Log Set (Complete)	24M15	1	H6197	1	24M25	1	24M25	1
9	Burner Assembly	H8585	1	H8585	1	H8587	1	H8587	1
10	Grate Assembly	H6526	1	H6526	1	H6314	1	H6314	1
11	Orifice, Main Burner—Natural Gas	99K74	1	60J80	1	99K76	1	24M10	1
11	Orifice, Main Burner—LP Gas	99K78	1	19L52	1	21L01	1	37G00	1
12	Bag Of Embers (Rockwool)	88L53	1	88L53	1	88L53	1	88L53	1
13	Bag Of Decorative Volcanic Stone	80L42	1	80L42	1	80L42	1	80L42	1
14	Gas Line Flexible Connector	93L32	1	93L32	1	93L32	1	93L32	1

Gas Controls—SIT Millivolt					
Item No.	Description	Natural Gas		Propane Gas	
		Part No.	Qty.	Part No.	Qty.
15	Gas Valve, SIT	H1657	1	88J53	1
16	Piezo Igniter	10K86	1	10K86	1
17	Pilot Assembly	69L17	1	69L18	1
18	Pilot Generator	60J79	1	60J79	1
19	Thermocouple	74L57	1	74L57	1
20	Pilot Tube	74L56	1	74L56	1
21	Electrode And Cable	H6212	1	H6212	1
22	Pilot Shield	H6347	1	H6347	1

Gas Controls—SIT Electronic					
Item No.	Description	Natural Gas		Propane Gas	
		Part No.	Qty.	Part No.	Qty.
23	Gas Valve, SIT	H8562	1	H8594	1
24	Pilot Assembly	H7268	1	H7269	1
25	Transformer	H8006	1	H8006	1
26	Pilot Shield	H3737	1	H3737	1
27	Digital Flame Control Module	H7272	1	H7272	1
28	Battery Holder	H8803	1	H8803	1
29	DFC Wiring Harness	H8601	1	H8601	1
30	CPI On/Off Switch	27K30	1	27K30	1

* Lennox Nameplate Logo, 12L15, is not included.

Contact a Lennox Hearth Products dealer to obtain any of these parts. Never use substitute materials. Use of non-approved parts can result in poor performance and safety hazards.

 **WARNING**

Failure to position the parts in accordance with these diagrams or failure to use only parts specifically approved with this appliance may result in property damage or personal injury.

 **AVERTISSEMENT**

Risque de dommages ou de blessures si les pièces ne sont pas installées conformément à ces schémas et ou si des pièces autres que celles spécifiquement approuvées avec cet appareil sont utilisées.

REPLACEMENT PARTS

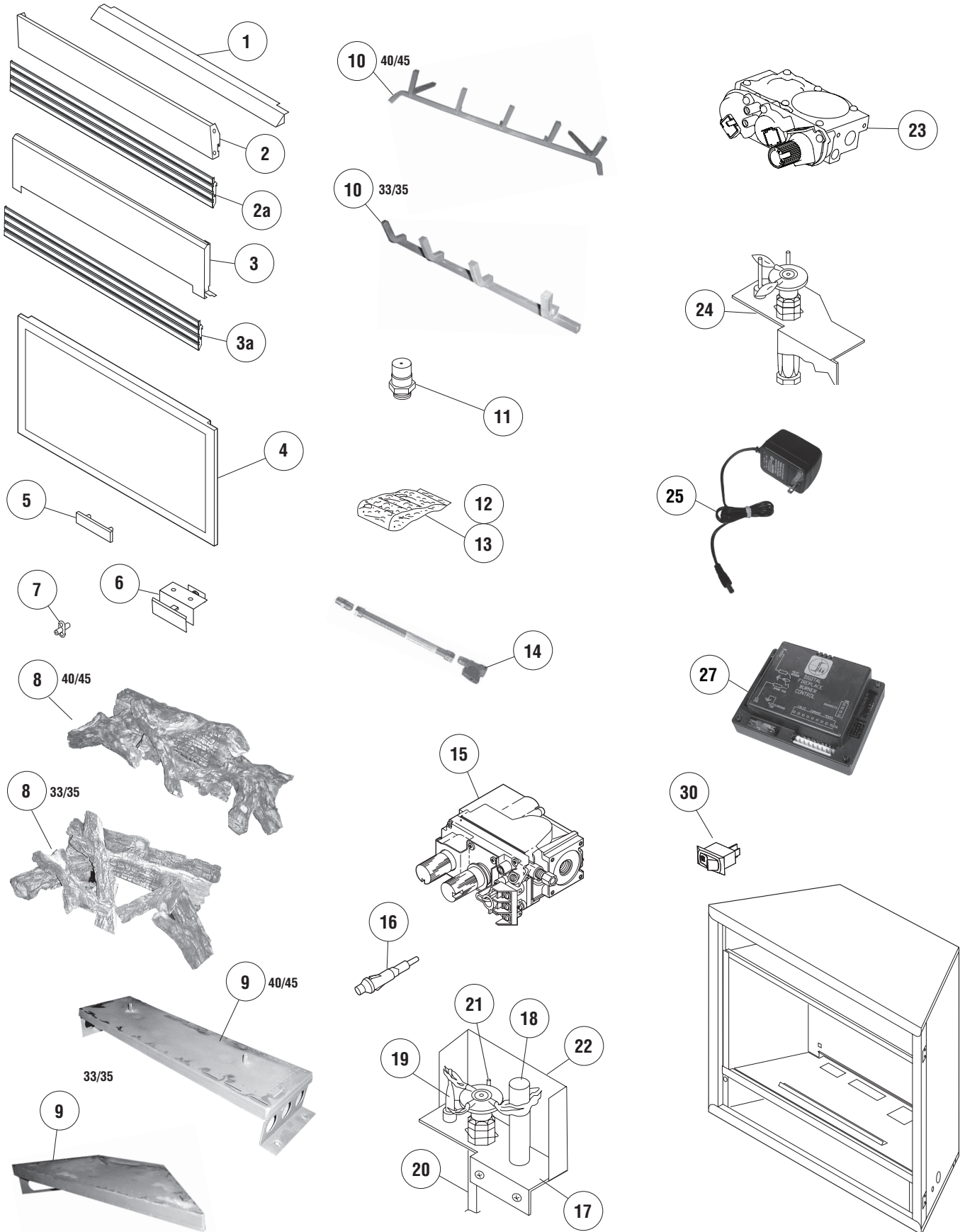

NOTE: DIAGRAMS & ILLUSTRATIONS ARE NOT TO SCALE.

Lennox Hearth Products reserves the right to make changes at any time, without notice, in design, materials, specifications, prices and also to discontinue colors, styles and products. Consult your local distributor for fireplace code information.

LENNOX®, the LENNOX design, DAVE LENNOX, the image of DAVE LENNOX and other related LENNOX marks are registered or common law trademarks of Lennox Industries Inc. and are used with permission.

Printed in U.S.A. © 2013 Lennox Hearth Products LLC

P/N 506017-06 Rev. B 01/2013



HEARTH PRODUCTS

1508 Elm Hill Pike, Suite 108 • Nashville, TN 37210