



## *Illustrated Parts List*

### *Pressure Washer / Lavadora de Presión*



This pressure washer is rated in accordance to the Pressure Washer Manufacture Association (PWMA) Standard PW101 (Testing and Rating Performance of Pressure Washers).

Questions? Help is just a moment away!  
Preguntas? La ayuda es justa un momento lejos!  
Call: Pressure Washer Helpline

Llame: Línea Directa del Lavadora a Presión - 1-888-611-6708 M-F 8-5 CT

Troy-Bilt® is a registered trademark of MTD Products Inc and is used under license to Briggs & Stratton Power Products, LLC.  
Troy-Bilt® es una marca de MTD y se usa abajo licencia a Briggs & Stratton Power Products, LLC.

#### **Model / Modelo**

Mfg. No.	Description / Descripción
020414-1	2,700 PSI Troy-Bilt

**Manual Part No.** 314895

Revision A

Rev. Date: 12/14/2011



<b>PRODUCT COMPONENTS</b>	<b>PAGES</b>
Main Unit .....	4
Pump .....	6
<b>Torque Specification Chart .....</b>	<b>Inside Back Cover</b>

## Main Unit

313465

NOTE: Unless noted otherwise, use the standard hardware torque specification chart.

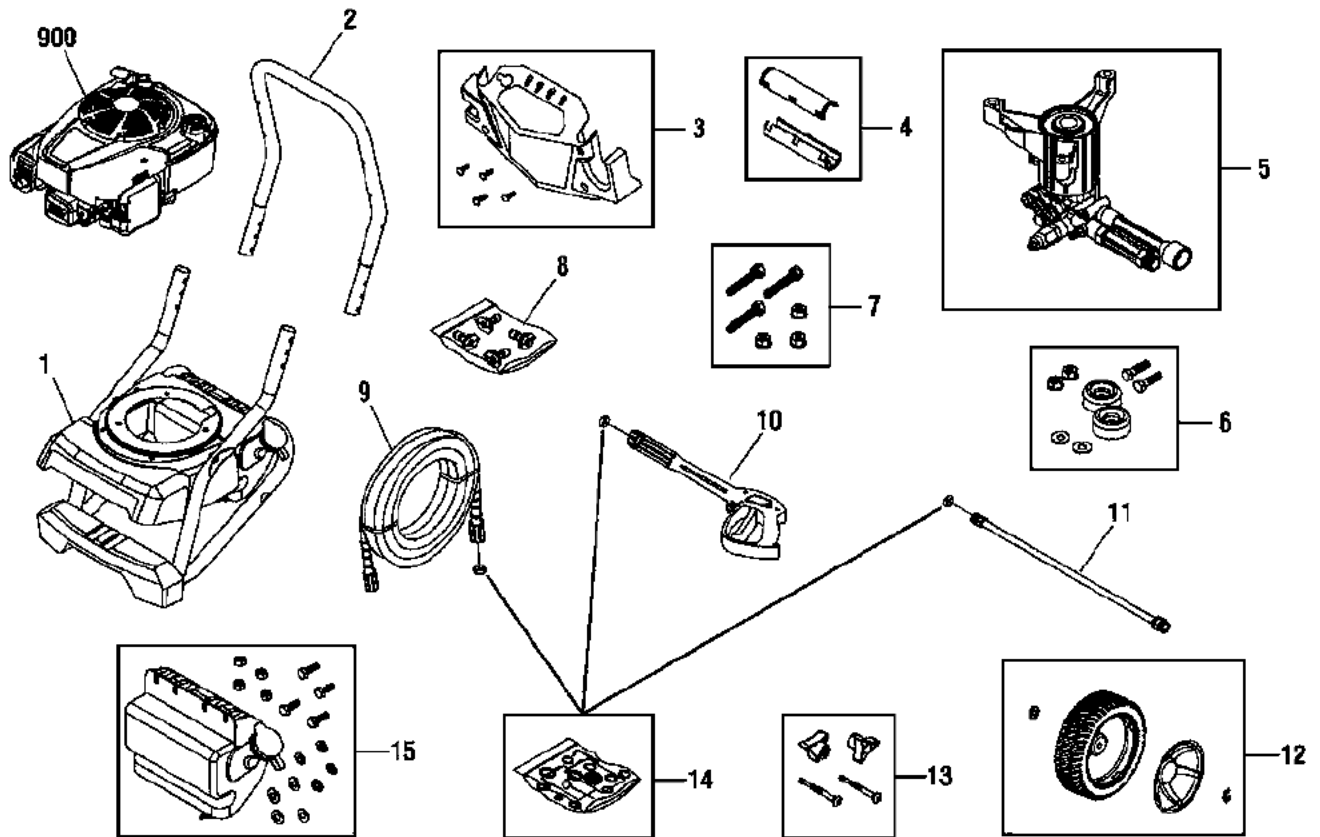

REF.	PART NO.	DESCRIPTION	REF.	PART NO.	DESCRIPTION
1	311970GS	BASE	--	200519GS	HUBCAP
2	310629BVGS	HANDLE	--	192050GS	E-RING
3	310790GS	BILLBOARD	13	311896GS	KIT, Hardware, Handle
--	195964GS	KIT, Tree Clips	14	196002GS	KIT, O-Rings
4	311969GS	GRIP	15	310800GS	TANK, Chemical
5	311966GS	PUMP	--	310804GS	CAP, Chemical Tank
6	192310GS	MOUNT, Vibration	--	310333GS	KIT, Fuel Valve
7	203526GS	KIT, Hardware, Pump Mounting	900	----	* ENGINE
8	314075GS	KIT, QC Nozzles	--	314085GS	MANUAL, Operators (Not Illustrated)
--	195983TGS	NOZZLE, QC Yellow	--	23139GS	KEY (Not Illustrated)
--	195983RGS	NOZZLE, QC White	--	199272GS	OIL BOTTLE (Not Illustrated)
--	195983AAGS	NOZZLE, QC Red	--	310788GS	DECAL, Unit (Not Illustrated)
--	198841GS	NOZZLE, QC Black	--	310789GS	DECAL, Shroud (Not Illustrated)
9	196006GS	HOSE	--	A1040JGS	HOSE, Chemical (Not Illustrated)
10	204627GS	GUN	--	201314GS	AXLE (Not Illustrated)
11	200595GS	EXTENSION, QC	--	194256GS	TAG, Warning (Not Illustrated)
12	202477GS	KIT, Wheel			

### Footnotes

\* Contact Engine Manufacturer

The above parts group applies to the following Mfg. Nos.:

020414-1 - 2,700 PSI Troy-Bilt

# Main Unit

313465

NOTE: Unless noted otherwise, use the standard hardware torque specification chart.

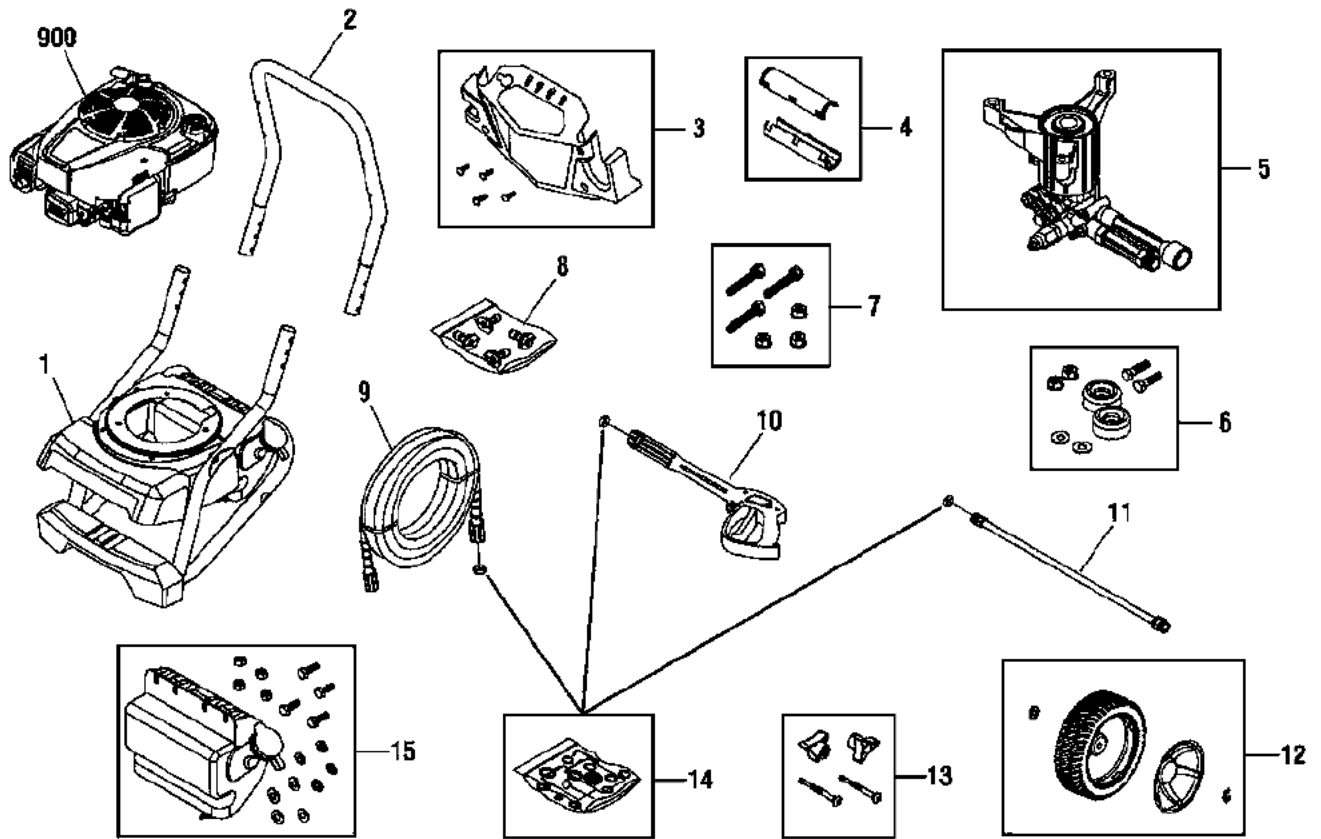

REF. PART NO.	DESCRIPTION	REF. PART NO.	DESCRIPTION
-- 6039	PUMP SAVER (Optional Accessory)		

## Footnotes

\* Contact Engine Manufacturer

The above parts group applies to the following Mfg. Nos.:

020414-1 - 2,700 PSI Troy-Bilt

# Pump

311039

NOTE: Unless noted otherwise, use the standard hardware torque specification chart.

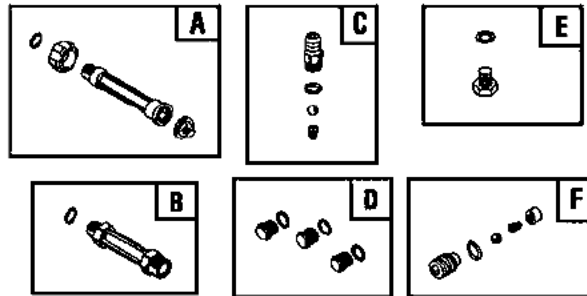
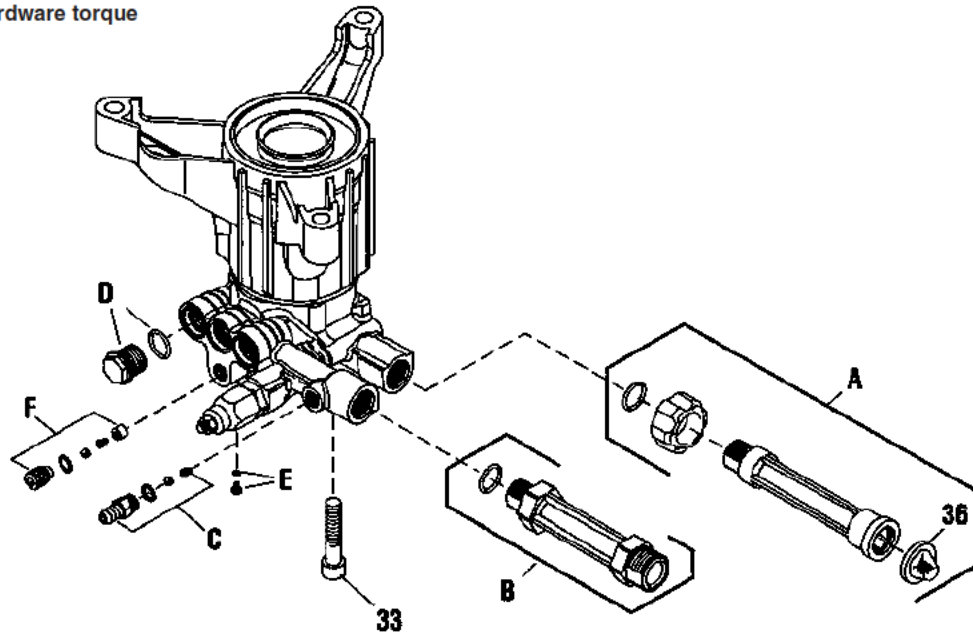

REF.	PART NO.	DESCRIPTION	REF.	PART NO.	DESCRIPTION
33	200275GS	SCREW			
36	B2384GS	FILTER, Garden Hose			
A	201496GS	* KIT, Water Inlet			
B	201497GS	* FITTING			
C	192914GS	* KIT, Chemical Injection			
D	317057GS	* KIT, Plug			
E	200350GS	* SCREW, Grub			
F	200349GS	* KIT, Easy Start			
--	208673BS	VALVE, Thermo Relief (Not Illustrated)			
--	6039	PUMP SAVER (Optional Accessory)			
--	6033	OIL BOTTLE (Optional Accessory)			

## Footnotes

\* Service Kit includes all parts shown in box.

The above parts group applies to the following Mfg. Nos.:

020414-1 - 2,700 PSI Troy-Bilt

# Hardware Identification & Torque Specifications

Torque Specification Chart								
FOR STANDARD METRIC MACHINE HARDWARE (Tolerance ± 20%)								
Property Class	5.6		8.8		10.9		12.9	
	Class 5.6		Class 8.8		Class 10.9		Class 12.9	
Size Of Hardware	in/lbs		in/lbs		in/lbs		in/lbs	
	ft/lbs	Nm.	ft/lbs	Nm.	ft/lbs	Nm.	ft/lbs	Nm.
M3	5.88	.56	13.44	1.28	19.2	1.80	22.92	2.15
M4	13.44	1.28	30.72	2.90	43.44	4.10	52.56	4.95
M5	26.4	2.50	60.96	5.75	5.97	8.10	7.15	9.7
M6	44.64	4.3	7.3	9.9	10.3	14	12.1	16.5
M7	5.2	7.1	12.1	16.5	16.9	23	19.9	27
M8	7.7	10.5	17.7	24	25	34	29	40
M10	15	21	35	48	50	67	59	81
M12	26	36	61	83	86.2	117	103	140
M14	42	58	101	132	136	185	162	220
M16	64	88	147	200	210	285	250	340
M18	89	121	202	275	287	390	346	470
M20	126	171	290	390	405	550	486	660
M22	169	230	390	530	559	745	656	890
M24	217	295	497	375	708	960	840	1140
M27	320	435	733	995	1032	1400	1239	1680
M30	435	590	995	1350	1401	1900	1681	2280
M33	590	800	1349	1830	1902	2580	2278	3090
M36	759	1030	1740	2360	2441	3310	2935	3980
M39	988	1340	2249	3050	3163	4290	3798	5150

The guides and ruler furnished below are designed to help you select the appropriate hardware.

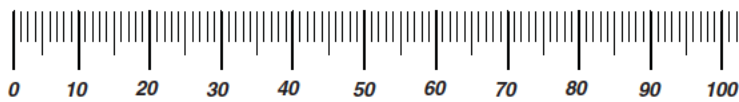

Nut, M8

Thread Diameter (mm)  
Inside Diameter (in)  
Threads per inch

Nut, 1/2-16

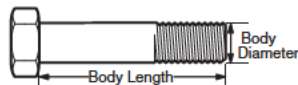

Screw, M8- 1.25 x 25

Thread Diameter (mm)  
Body Diameter  
Distance between threads (mm)  
Threads per inch  
Body Length (mm)  
Body Length (in)

Screw, 1/2- 16 x 2

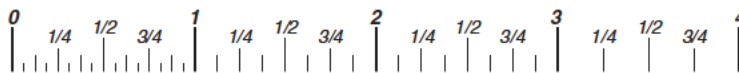

## Standard Hardware Sizing

When a washer or nut is identified as 1/2" (M8), this is the *Nominal size*, meaning the *inside diameter* is 1/2 inch (8mm metric thread diameter); if a second number is present it represents the *threads per inch* (distance between threads).

When bolt or capscrew is identified as 1/2 - 16 x 2" (M8 - 1.25 x 50), this means the *Nominal size*, or body diameter is 1/2 inch (8mm metric thread diameter), the second number, 16, represents the *threads per inch*, (1.25 thread diameter). The final number is the body length of the bolt or screw, 2 inches (50mm).

Torque Specification Chart						
FOR STANDARD MACHINE HARDWARE (Tolerance ± 20%)						
Hardware Grade	No Marks		SAE Grade 5		SAE Grade 8	
	SAE Grade 2		SAE Grade 5		SAE Grade 8	
Size Of Hardware	in/lbs		in/lbs		in/lbs	
	ft/lbs	Nm.	ft/lbs	Nm.	ft/lbs	Nm.
8-32	19	2.1	30	3.4	41	4.6
8-36	20	2.3	31	3.5	43	4.9
10-24	27	3.1	43	4.9	60	6.8
10-32	31	3.5	49	5.5	68	7.7
1/4-20	66	7.6	8	10.9	12	16.3
1/4-28	76	8.6	10	13.6	14	19.0
5/16-18	11	15.0	17	23.1	25	34.0
5/16-24	12	16.3	19	25.8	29	34.0
3/8-16	20	27.2	30	40.8	45	61.2
3/8-24	23	31.3	35	47.6	50	68.0
7/16-14	30	40.8	50	68.0	70	95.2
7/16-20	35	47.6	55	74.8	80	108.8
1/2-13	50	68.0	75	102.0	110	149.6
1/2-20	55	74.8	90	122.4	120	163.2
9/16-12	65	88.4	110	149.6	150	204.0
9/16-18	75	102.0	120	163.2	170	231.2
5/8-11	90	122.4	150	204.0	220	299.2
5/8-18	100	136	180	244.8	240	326.4
3/4-10	160	217.6	260	353.6	386	525.0
3/4-16	180	244.8	300	408.0	420	571.2
7/8-9	140	190.4	400	544.0	600	816.0
7/8-14	155	210.8	440	598.4	660	897.6
1-8	220	299.2	580	788.8	900	1,244.0
1-12	240	326.4	640	870.4	1,000	1,360.0

## NOTES

- These torque values are to be used for all hardware excluding: locknuts, self-tapping screws, thread forming screws, sheet metal screws and socket head setscrews.
- Recommended seating torque values for locknuts:
  - for prevailing torque locknuts - use 65% of grade 5 torques.
  - for flange whizlock nuts and screws - use 135% of grade 5 torques.
- Unless otherwise noted on assembly drawings, all torque values must meet this specification.

## Common Hardware Types

Hex Head Capscrew



Washer



Lockwasher

Carriage Bolt



Hex Nut

## Wrench & Fastener Size Guide

1/4" Bolt or Nut Wrench—7/16"	5/16" Bolt or Nut Wrench—1/2"	3/8" Bolt or Nut Wrench—9/16"	7/16" Bolt or Nut Wrench (Bolt)—5/8" Wrench (Nut)—11/16"	1/2" Bolt or Nut Wrench—3/4"
M6 Bolt or Nut Wrench—10mm	M8 Bolt or Nut Wrench—13mm	M10 Bolt or Nut Wrench—17mm	M12 Bolt or Nut Wrench—19mm	M14 Bolt or Nut Wrench—22mm



**Briggs & Stratton Power Products Group, LLC**

Copyright© 2011 Briggs & Stratton Power Products Group, LLC. All rights reserved. No part of this page can be reproduced or transmitted in any form by any means without the express written permission of Briggs & Stratton Power Products Group, LLC.