

# Model GX Series

Triplex  
Plunger Pump  
Operating Instructions /  
Repair Instructions  
Manual

Consumer Pump

Horizontal / Vertical Pump  
with built-in Thermal  
Relief Valve and Siphon  
Injector

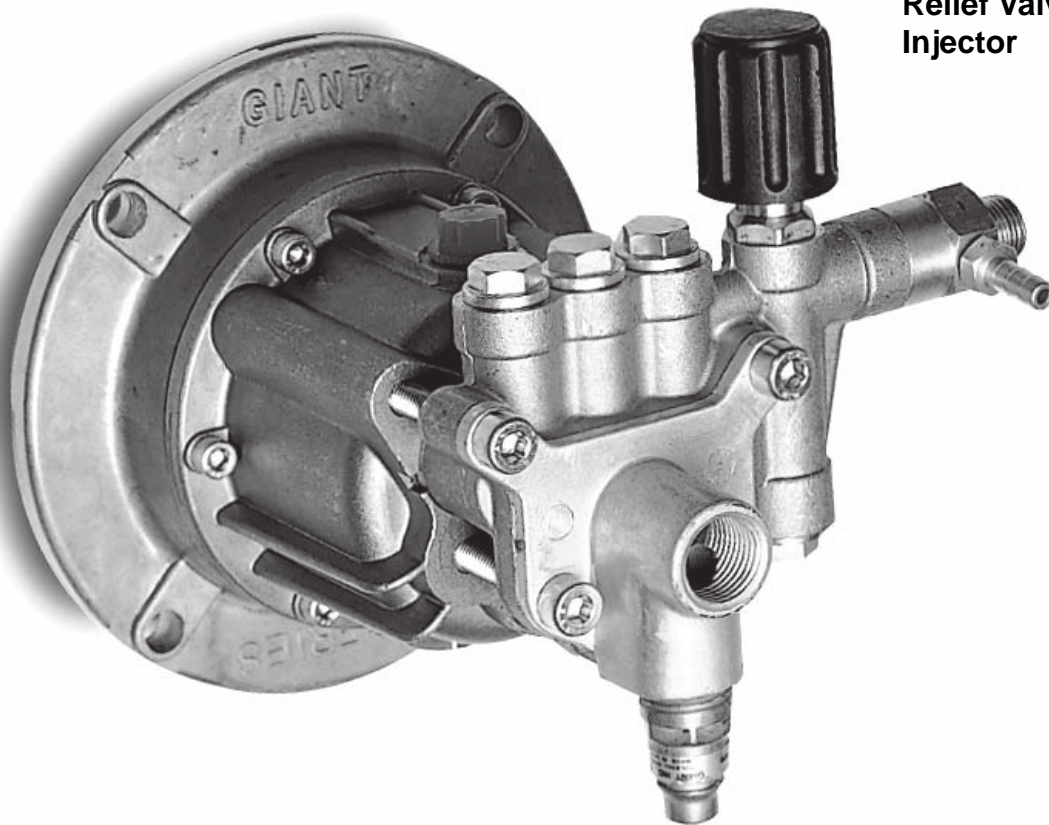

## Contents:

Installation Instructions:	Page 2
Pump Specifications:	Page 3
Exploded View / Kits:	Page 4
Torque Specifications:	Page 5
Repair Instructions:	Pages 6 - 7
Dimensions:	Back
Warranty Information:	Back

MADE IN THE USA



# INSTALLATION INSTRUCTIONS

**Installation of the Giant Industries Inc., pump is not a complicated procedure, but there are some basic steps common to all pumps.**

**The following information is to be considered as a general outline for installation.**

1. The pump should be installed flat on a base to a maximum of a 15 degree angle of inclination to ensure optimum lubrication.
2. The inlet to the pump should be sized for the flow rate of the pump with no unnecessary restrictions that can cause cavitation. Teflon tape should be used to seal all joints. **Maximum inlet fluid temperature is 80°F.**
3. The discharge plumbing from the pump should be properly sized to the flow rate to prevent line pressure loss to the work area. It is essential to provide a safety bypass valve between the pump and the work area to protect the pump from pressure spikes in the event of a blockage or the use of a shut-off gun.
4. Before beginning operation of your pumping system, remember: Check that the crankcase and seal areas have been properly lubricated per recommended schedules. Do not run the pump dry for extended periods of time. Cavitation will result in severe damage. Always remember to check that all plumbing valves are open and that pumped media can flow freely to the inlet of the pump.

Finally, remember that high pressure operation in a pump system has many advantages. But, if it is used carelessly and without regard to its potential hazard, it can cause serious injury.

## IMPORTANT OPERATING CONDITIONS

**Failure to comply with any of these conditions invalidates the warranty.**

1. Your Giant Industries replacement pump comes pre-filled to the proper level with synthetic oil although checking for the proper oil level is advised after removing the red shipping plug and installing your black crankcase breather tube.
2. The proper level of oil in the GXH2525 series pump will be just slightly above half full. This pump does not have a sight glass so you will need to look into the pump from the top in order to view your oil level. The crankcase oil capacity for your GXH2525 Series Horizontal pumps 4.1 ounces of oil.
3. **To change or add oil use only Mobil 1 20W50 Full Synthetic oil**
4. **DO NOT OVERFILL CRANKCASE**
5. Crankcase oil should be changed after the first 50 hours of operation, then at regular intervals of 100 hours or less depending on the operating conditions of the pump.
6. Pump operation must not exceed the rated pressure, volume or a maximum rate of 3450 RPM'S. Failure to follow these instructions could result in damage to your pressure pump.
7. Do not flow Acids' Alkaline or Abrasive fluids through your GXH2525 series pressure pump for cleaning purposes. These fluids must be applied with the downstream chemical injector provided with your pressure pump.
8. Your GXH2525 series pump should be conditioned after every use to help prevent any type of corrosion from building up inside of the part and components of your pump head. We suggest you use Pump Saver Part # 7074403GS, RV Antifreeze or WD-40 to help prevent corrosion inside the brass head of your pump.
9. Always winterize you pressure pump before storing your pump in climates that will have any chance of below freezing temperatures. A small amount of water left in your pump could cause serious damage to your pump and will not be covered under the manufactures warranty.

# Specifications Model GX Series

Volume . . . . .	2.5 GPMt
Maximum Discharge Pressure. . . . .	2600 PSI
Maximum Inlet Pressure. . . . .	Up to 90 PSIG <sup>1</sup>
RPM. . . . .	3450
Plunger Diameter. . . . .	16mm
Stroke. . . . .	5.1mm (7.1° angle)
Crankcase Oil Capacity. . . . .	4.1 fl. oz. (121 ml)
. . . . .	Mobile 1 20W 50 Full Synthetic
Temperature of Pumped Fluids. . . . .	Up to 80°F (27°C)
Inlet Port. . . . .	1/2" NPT
Discharge Ports. . . . .	3/8" NPT
Shaft Rotation. . . . .	Either Direction <sup>2</sup>
Weight. . . . .	.9 lbs.
Width. . . . .	8.325"
Height. . . . .	6.45"
Swash Plate Bore (Horizontal). . . . .	3/4" x 3/16" Keyway
Swash Plate Bore (Vertical). . . . .	7/8" x 3/16" Keyway
Valve Type. . . . .	Polyamide Plastic

<sup>1</sup> A 25 PSIG minimum inlet pressure is required.

<sup>2</sup> The pump itself can be driven in either direction of rotation; however, the cooling fan on TEFC motors must always be positioned so that the cooling air is drawn from the non-drive end of the motor towards the pump.

<b>GX2025 HORSEPOWER REQUIREMENTS</b>					
RPM	GPM	1000 PSI	1500 PSI	1700 PSI	2500 PSI
3450	2.0	1.4	2.1	2.7	3.4

<b>GX2325 HORSEPOWER REQUIREMENTS</b>					
RPM	GPM	1000 PSI	1500 PSI	1700 PSI	2500 PSI
3450	2.3	1.6	2.4	3.2	3.9

<b>GX2525 HORSEPOWER REQUIREMENTS</b>					
RPM	GPM	1000 PSI	1500 PSI	2000 PSI	2600 PSI
3450	2.5	1.7	2.6	3.4	4.3

## HORSEPOWER RATINGS

The rating shown are the power requirements for the pump. Gas engine power outputs must be approximately twice the pump power requirements shown.

We recommend a 1.15 service factor be specified when selecting an electric motor as the power source. To compute specific pump horsepower requirements, use the following formula:

$$HP = (GPM \times PSI) / 1460$$

For example, a GXV2325-111 is a GX pump that produces 2.3 GPM @ 2500 PSI, has a injector with a 1.9mm Oriface, 1/2" thermal relief valve & 3/4" swash plate bore.

## GX SERIES PARTS LIST

ITEM	Part	Description	QTY	ITEM	Part	Description	QTY
1	07805	Radial Shaft Seal	1	29	06227	8mm Ball	1
2*	06310	Adapting Flange	1	30	07917A	Washer	1
3	06294	O-Ring (86 x 2.5mm)	1	31	07918A	Adjusting Spring	1
4	06300	Rear Bearing	1	32	07919	Pressure Spring	1
5+	06326	Wobble plate 7.1 degree horizontal, 3/4"	1	33***	06524	Adjusting Screw	1
5**	06331	Wobble plate 7.1 degree vertical, 7/8"	1	34***	06324	Adjusting Screw Plug	1
6	06301	Front Bearing	1	35	06286	Manifold	1
7	06289	Spring Disk	3	36	06295	Discharge Valve Cone	3
8	06287	16mm Plunger	3	38	07910A	Triangle O-Ring	1
9	06288	Plunger Spring	3	39	06298	Suction Flange	1
10	06299	Socket Bolt (1/4-20x3/4 10.9 GRD)	6	40	06302	Stud Bolt (M8x1.25x50mmGRD8.8SHCS)	4
11	08192	Gasket	1	41****	12326	Kick Back O-Ring	1
12	06273	Oil Drain Plug	1	42****	12325	Kick Back Valve Cone	1
13	06282	Crankcase	1	43****	12328	Kick Back Spring	1
14	08083	Vent Cap (Horizontal Only)	1	44 <sup>A</sup>	06727	Oriface, 1.8mm	1
15	06316	16mm Oil Seal(TTO)	3	44 <sup>A</sup>	06339	Oriface, 2.1mm	1
17	06292	Spacer	3	44 <sup>A</sup>	06340	Oriface, 2.3mm	1
18	07374	Valve Spring	6	45	06312	O-Ring in Nozzle	1
19	06267	Guided P-Valve	3	46	07913	O-Ring	1
20	06290	Pressure Ring	3	47	06303	Injector Retainer	1
21	06315	16mm V-Sleve	3	48	23009	Spring	1
22	06296	Discharge Plug	4	49	23010-0100	Ball	1
23***	12007	O-Ring	5	50	12516-0001	O-Ring	1
24	06304	Piston	1	51	12517	Hose Barb	1
25	1231-0002	Back-up ring	2	52	07939	Nut	1
26***	07937	O-Ring	2	53	07044	Locknut	1
27	08638	O-Ring of Push Seat	1	54	07045	Handwheel	1
28	06256	Push in Seat	1	55	07068	Locking Nut W/Nylon Inset	1
				56	07046	Cover	1
				75	23422-N	Thermal Relief Valve	1

<sup>A</sup> = See pump numbering system on page 7.

\* When ordering 06310, please order 17026 which includes 06300, 07805, and 06294.

\*\* When ordering 06331, please order 17032 which includes 06331, 06301, and shaft ring.

\*\*\* Optional Non-Handle Model - (Item 23\_ O-Ring p/n 12007, (Item 26) O-Ring p/n 07937, (Item 33) Adjusting Screw p/n 06323, (Item 34) Adjusting Screw Plug p/n 06324.

\*\*\*\* Optional Non-Injector Model - (Item 41) Kick Back Valve O-Ring p/n 12326, (Item 42) Kick Back Valve Cone p/n 12325 (Item 43) Kick back Spring p/n 12328, (Item 47) Kick Back Valve Retainer p/n 12340.

+ When ordering 06326, please order 17020 which includes 06326, 06301, and shaft ring.

++ When ordering 06419, please order 17171 which includes 06419, 06159, and 06301

### MOUNTING ACCESSORIES (Sold Separately)

Item	Description
09103(EX) <sup>1</sup>	Gasoline Flange Kit (excluding GXH2525A models)
09605	Gasoline Flange Kit (GXH2525A only)
07435	Bolts for 09103/09605

<sup>1</sup> "EX" Suffix added for engines requiring an external pilot

## GX SERIES TORQUE SPECIFICATIONS

Position	Item	Description	Torque Amount
10	06299	Socket Bolt	100 in.-lbs.
40	06302	Stud Bolt	150 in.-lbs.

# GX Series EXPLODED VIEW

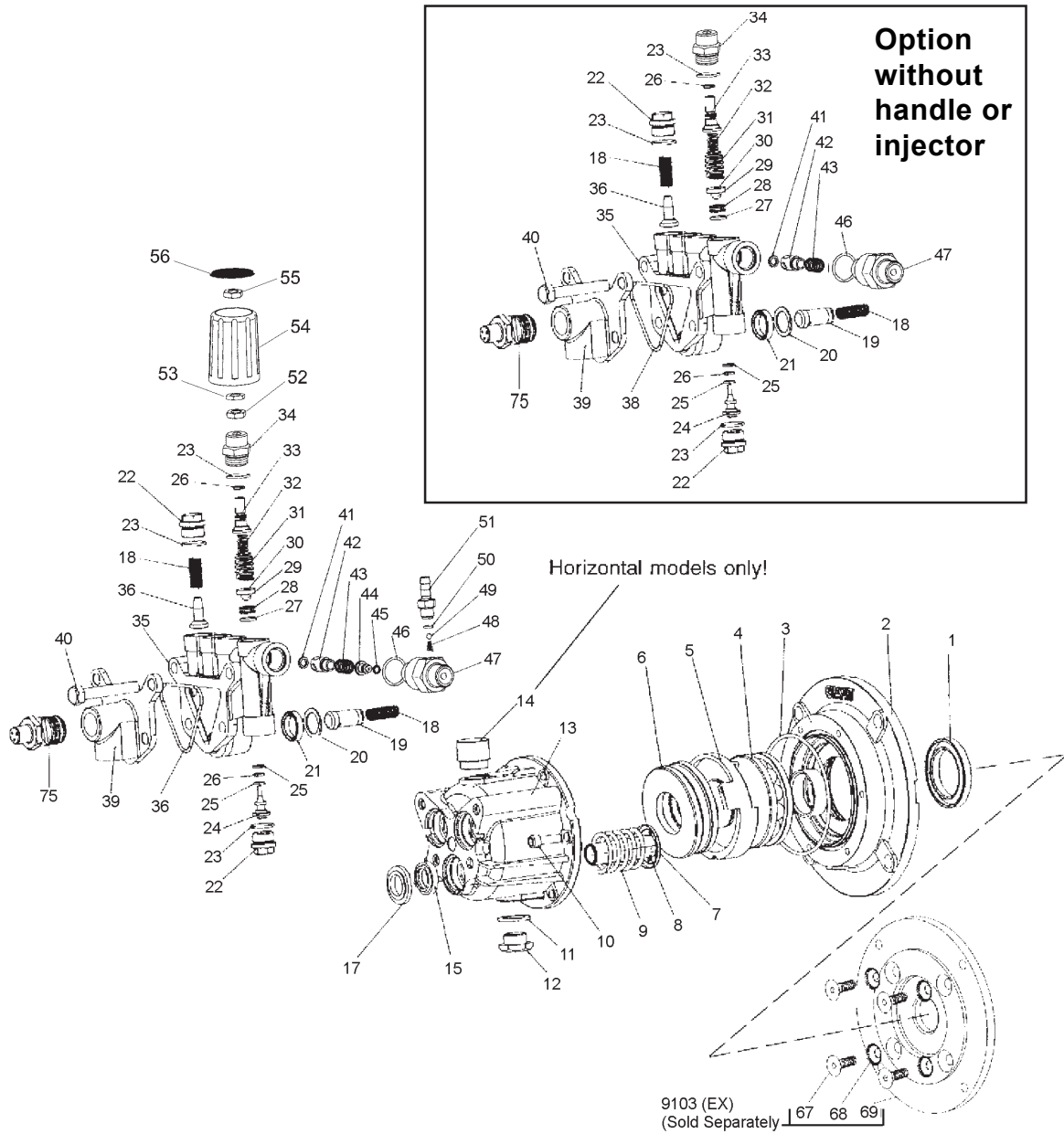

## Plunger Packing Kit #09465

<u>Item</u>	<u>Part #</u>	<u>Description</u>	<u>Qty.</u>
20	06290	Support Ring	3
21	06315	V-Sleve	3

## Oil Seal Kit #09468

<u>Item</u>	<u>Part #</u>	<u>Description</u>	<u>Qty.</u>
15	06316	Plunger Oil Seal	3

## Valve Assembly Kit #09466

<u>Item</u>	<u>Part #</u>	<u>Description</u>	<u>Qty.</u>
18	07374	Valve Spring	6
19	06267	Guided P_Valve	3
36	06295	Discharge Valve Cone	3

## Unloader Repair Kit #09467

<u>Item</u>	<u>Part #</u>	<u>Description</u>	<u>Qty.</u>
23	12007	Valve Spring	6
25	12031-0002	Back-up Ring	3
26	07937	O-Ring	3
27	08638	O-Ring	3
28	06256	Seat	3
29	06227	8mm Ball	3
41	12326	O-Ring	3

## REPAIR INSTRUCTIONS - GX SERIES

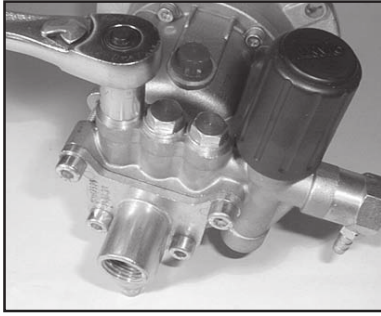

1. With a 14mm socket wrench, remove the three discharge valve plugs (22). Inspect the valve plug o-rings (23) for wear, and replace as necessary.

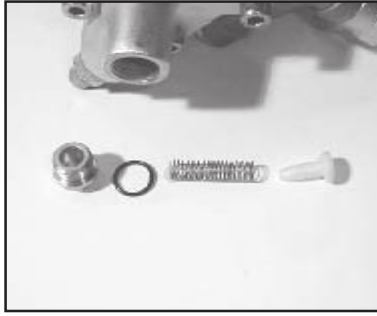

2. Remove the valve spring (18) and valve cone (36) from the manifold (35). Inspect the parts for wear and replace as necessary.

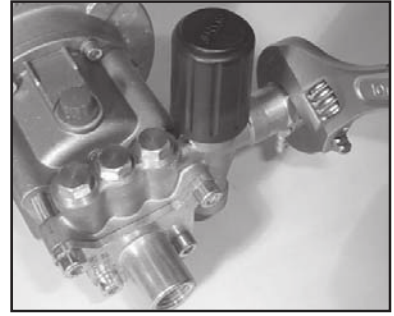

3. With a crescent wrench, remove the kickback valve spring retainer (47). Inspect the o-ring (46) for wear and replace as necessary. Remove the kickback valve spring (43), kickback valve cone (42), and the o-ring (41) from the manifold (35). Inspect the parts for wear and replace as necessary.

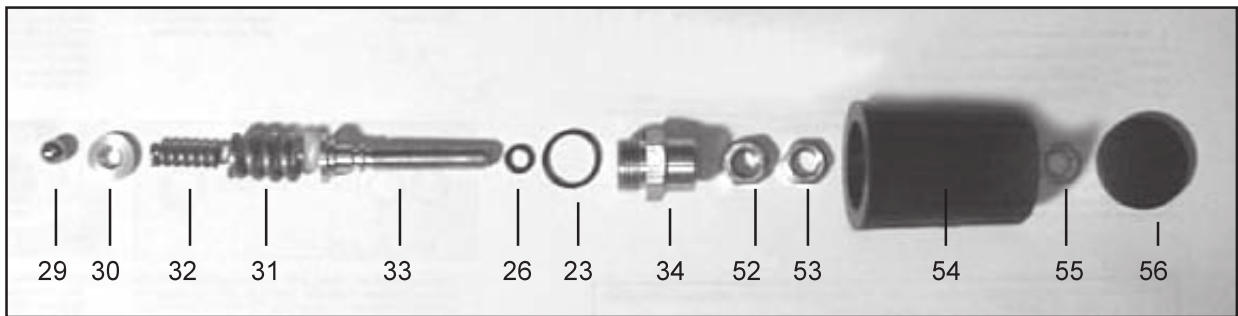

4. With a 19mm wrench, remove the adjusting screw plug (34). Unscrew the adjusting screw (33) from the adjusting screw plug (34). Inspect the o-rings (23 & 26) for wear and replace as necessary.

5. Remove the adjusting spring (31), pressure spring (32), washer (30) and by pass valve ball (29) from the manifold (35). Inspect the parts for wear and replace as necessary.

***Optional pump without handle - exclude items (52, 53, 54, 55, 56).***

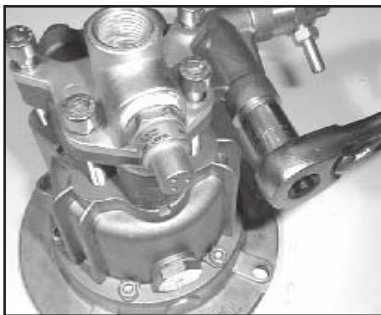

6. With a 14mm socket wrench, remove the guide plug (22) and o-ring (23).

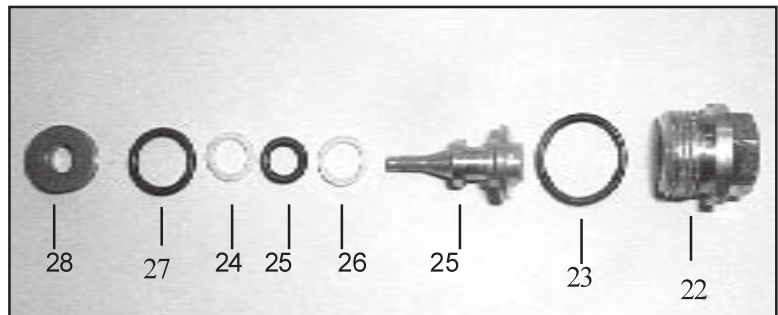

7. Remove the piston (24), o-ring (26), and backup rings (25). Remove the bypass valve seat (28). Inspect the parts for wear and replace as necessary. **IMPORTANT! Make sure that the shoulder on bypass valve seat (28) is facing the discharge plug (22).**

# GX2525 EXPLODED VIEW

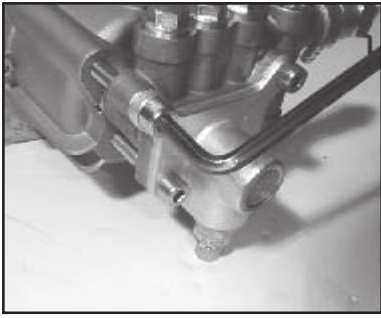

8. Next, remove the four manifold bolts (40) with a 6mm allen wrench.

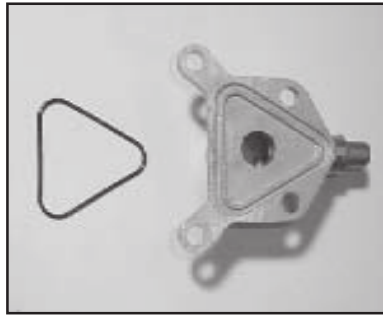

9. Remove the suction flange (39) and flange o-ring (38). Inspect the o-ring for wear and replace as necessary.

10. Tap the back of the manifold (35) with a rubber mallet to dislodge, and slide off the plungers. (8). Take note of the position of the discharge port so as to place the manifold in the same position during reassembly.

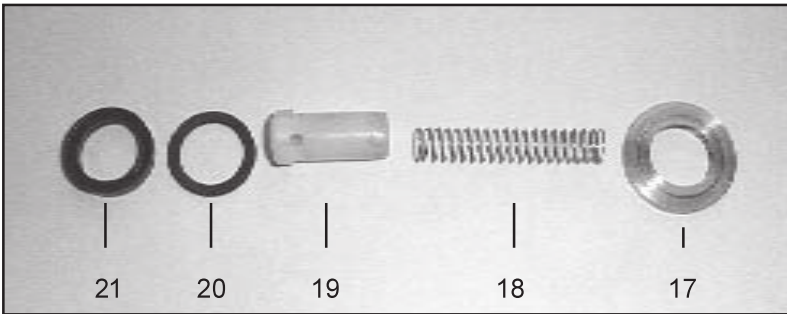

11. Remove the guided p-valve, (19), valve springs (18), v-sleeves (21) and pressure rings (20). Inspect for wear and replace as necessary. Remove the spacer ring (17) from the plungers (8).

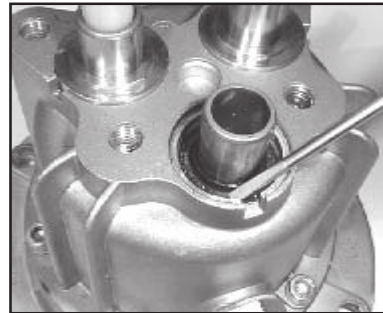

12. If the crankcase oil seals (15) are to be replaced, they can be removed by prying loose with a screwdriver. Take care not to make contact with the plunger (8) and pry out the oil seals from their housing. Seals should not be re-installed until after step #16.

13. Reassemble in reverse order. Fill the crankcase with the proper amount of oil (see specifications page 3) The pump is now ready for operation.

## NOTES:

---

---

---

---

---

---

---

---

---

---

---

---

---

---

---

---

---

---

---

---

---

---

---

## GX Series Dimensions inches (mm)

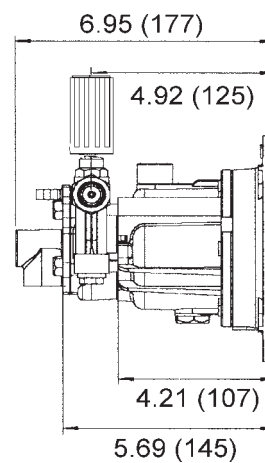
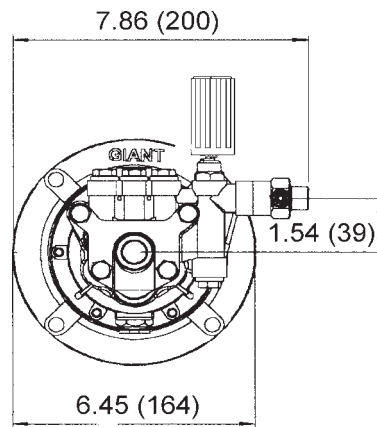

### GIANT INDUSTRIES LIMITED WARRANTY

Giant Industries, Inc. pumps and accessories are warranted by the manufacturer to be free from defects in workmanship and material as follows:

1. For portable pressure washers and self-service car wash applications, the discharge manifolds are guaranteed for the life of the pump. Our other pump parts, used in portable pressure washers and in car wash applications, are warranted for five years from the date of shipment for all pumps used in NON-SALINE, clean water applications.
2. One (1) year from the date of shipment for all other Giant industrial and consumer pumps.
3. Six (6) months from the date of shipment for all rebuilt pumps.
4. Ninety (90) days from the date of shipment for all Giant accessories.

This warranty is limited to repair or replacement of pumps and accessories of which the manufacturer's evaluation shows were defective at the time of shipment by the manufacturer. The following items are NOT covered or will void the warranty:

1. Defects caused by negligence or fault of the buyer or third party.
2. Normal wear and tear to standard wear parts.
3. Use of repair parts other than those manufactured or authorized by Giant.
4. Improper use of the product as a component part.
5. Changes or modifications made by the customer or third party.
6. The operation of pumps and or accessories exceeding the specifications set forth in the Operations Manuals provided by Giant Industries, Inc.

Liability under this warranty is on all non-wear parts and limited to the replacement or repair of those products returned freight prepaid to Giant Industries which are deemed to be defective due to workmanship or failure of material. A Returned Goods Authorization (R.G.A.) number and completed warranty evaluation form is required prior to the return to Giant Industries of all products under warranty consideration. Call (419)-531-4600 or fax (419)-531-6836 to obtain an R.G.A. number.

Repair or replacement of defective products as provided is the sole and exclusive remedy provided hereunder and the MANUFACTURER SHALL NOT BE LIABLE FOR FURTHER LOSS, DAMAGES, OR EXPENSES, INCLUDING INCIDENTAL AND CONSEQUENTIAL DAMAGES DIRECTLY OR INDIRECTLY ARISING FROM THE SALE OR USE OF THIS PRODUCT.

THE LIMITED WARRANTY SET FORTH HEREIN IS IN LIEU OF ALL OTHER WARRANTIES OR REPRESENTATION, EXPRESS OR IMPLIED, INCLUDING WITHOUT LIMITATION ANY WARRANTIES OR MERCHANTABILITY OR FITNESS FOR A PARTICULAR PURPOSE AND ALL SUCH WARRANTIES ARE HEREBY DISCLAIMED AND EXCLUDED BY THE MANUFACTURER.



GIANT INDUSTRIES, INC., 900 N. Westwood Ave., P.O. Box 3187, Toledo, Ohio  
43607 PHONE (419) 531-4600, FAX (419) 531-6836, www.giantpumps.com  
© Copyright 2004 Giant Industries, Inc.

3/04 GX2525.PM6